



Office of the
Deputy Prime Minister

Creating sustainable communities

*Effect of reduced pressures on
performance of firefighting
branches in tall buildings*

Aspects of high-rise firefighting



Office of the
Deputy Prime Minister
Creating sustainable communities

Effect of reduced pressures on performance of firefighting branches in tall buildings

Aspects of high-rise firefighting

Fire Research Technical Report 3/2005

December 2004

Simon Hunt and Guy Roberts
Fire Statistics and Research Division

Office of the Deputy Prime Minister: London

The findings and recommendations in this report are those of the consultant authors and do not necessarily represent the views or proposed policies of the Office of the Deputy Prime Minister.

Following the reorganisation of the government in May 2002, the responsibilities of the former Department of the Environment, Transport and the Regions (DETR) and latterly Department for Transport, Local Government and the Regions (DTLR) in this area were transferred to the Office of the Deputy Prime Minister.

The Office of the Deputy Prime Minister
Eland House
Bressenden Place
London SW1E 5DU
Telephone: 020 7944 4400
Web site: www.odpm.gov.uk

© Crown copyright 2004.

Copyright in the typographical arrangement rests with the Crown.

This publication, excluding logos, may be reproduced free of charge in any format or medium for research, private study or for internal circulation within an organisation. This is subject to it being reproduced accurately and not used in a misleading context. The material must be acknowledged as Crown copyright and the title of the publication specified.

For any other use of this material, please write to HMSO Licensing, St Clements House, 2-16 Colegate, Norwich NR3 1BQ. Fax: 01603 723000 or e-mail: licensing@hmso.gov.uk.

Further copies of this publication are available from:

ODPM Publications
PO Box 236
Wetherby
West Yorkshire
LS23 7NB
Tel: 0870 1226 236
Fax: 0870 1226 237
Textrphone: 0870 1207 405
E-mail: odpm@twoten.press.net
or online via www.odpm.gov.uk

Printed in Great Britain on material containing 75% post-consumer waste and 25% ECF pulp.

ISBN 1 85112 762 3

December 2004

Reference no. 04LGFG02767(3)

Contents

	Executive Summary	5
	Background	8
1.0	Introduction	9
2.0	Provision of rising mains in tall buildings	11
	Current Requirements: Approved Document B, Fire Safety. 2000	11
	BS 5306: Part 1:1976 Fire Extinguishing installations and equipment on premises.	12
	Performance criteria for rising mains used in practical trials	12
3.0	Compartment firefighting training and tactics	13
	HSE improvement notice to South Wales Fire Authority, July 1996	13
	Fire Service Manual volume 2: fire service operations – compartment fires and tactical ventilation	13
	Fire behaviour training instructor course	13
	Fire Service Manual, volume 4: fire service training, guidance and compliance framework for compartment fire behaviour training	13
	The provision and use of work equipment regulations 1998	14
	Techniques of water application.	15
4.0	Development of subjective criteria	17
5.0	Branch performance trials	19
	Background and definitions of terms	19
	Description of hydraulic arrangement	20
	Criteria used for evaluation trials	21
	Experimental method for initial trials	21
	Full branch performance trials	22
	Experimental method for full branch performance trials	22
6.0	Combining branch performance with firefighting attack from a rising main	23
	Experimental method	24
	Use of 51mm diameter hose	24
7.0	Results	25
8.0	Discussion of results	31
	Branches not meeting the minimum subjective criteria	31
	Results from the professional panel	31
	Branches meeting the minimum subjective criteria	32
	Results of combining branch performance with firefighting attack from a rising main	32
9.0	Conclusions	35
10.0	Recommendations	37

List of Figures

Figure 1: Definition of terms used for branch performance trials	19
Figure 2: Hydraulic arrangement	20
Figure 3: Examples of digital images of jet/spray patterns	21
Figure 4: Minimum operating branch pressures and corresponding flowrates	25
Figure 5: Recorded branch pressure, corresponding branch pass pressure and flowrate when supplied through 69m of 45mm hose at 4 bars pump pressure.	26
Figure 6: Recorded branch pressure, corresponding branch pass pressure and flowrate when supplied through 69m of 45mm hose at 5 bars pump pressure.	26
Figure 7: Recorded branch pressure, corresponding branch pass pressure and flowrate when supplied through 69m of 51mm hose at 4 bars pump pressure	27
Figure 8: Recorded branch pressure, corresponding branch pass pressure and flowrate when supplied through 69m of 51mm hose at 5 bars pump pressure	27
Figure 9: Recorded branch pressure, corresponding branch pass pressure and flowrate when supplied through 69m of 70mm hose at 4 bars pump pressure.	28
Figure 10: Recorded branch pressure, corresponding branch pass pressure and flowrate when supplied through 69m of 70mm hose at 5 bars pump pressure.	28
Figure 11: Pressure required to generate a flow of 500 litres/min through 69m of 45mm hose with branches under assessment	29
Figure 12: Pressure required to generate a flow of 500 litres/min through 69m of 51 mm hose with branches under assessment	29
Figure 13: Pressure required to generate a flow of 500 litres/min through 69m of 70 mm hose with branches under assessment	30

List of Tables

Table 1: Details of branches not meeting the minimum subjective criteria	31
--------------------------------------------------------------------------	----

List of Equations

Equation 1: Estimate of static loss at 60m elevation	33
------------------------------------------------------	----

Appendix A

Details of Branches	38
---------------------	----

Appendix B

Results of Branch Performance Trials	39
--------------------------------------	----

References

	50
--	----

Executive Summary

The Building Disaster Assessment Group (BDAG) was established to consider the issues, for fire authorities and their fire and rescue services in the UK, that have been highlighted by the World Trade Centre (WTC) incident of 11th September 2001. A principle aim of this group is to promote the health and safety of firefighters and building occupants by ensuring that building design reflects the operational response and practices of the fire and rescue service, and equally that operational practices reflect building design assumptions.

The amount of water required to fight extreme fires in high-rise buildings is an issue that has arisen as a result of the attacks on the WTC on September 11th 2001, but which is relevant for all high-rise fire incidents.

Firefighting shafts containing rising mains are provided to assist the fire and rescue service in accessing and fighting fires in tall buildings. The rising mains may be either a dry main, which is supplied from a fire appliance pump during an incident, or a wet main, which is permanently charged with water. Where dry mains are provided the pressure available at the firefighting branch reduces with increasing elevation due to the static head of the water in the rising main and frictional losses. In very tall buildings these losses will ultimately exceed the pressure supplied from the fire appliance pump supplying the main. For this reason in the UK, in buildings over 60m, the mains are permanently charged to provide a pressure-regulated flow.

However, there is little data currently available to establish whether the current provisions and corresponding fire and rescue service procedures are appropriate. There is also a pressing short-term need to ensure that firefighting techniques in tall buildings align to the equipment used and facilities provided. Where techniques do not align with equipment then the changes needed to support firefighting in tall buildings should be identified.

This report details work undertaken to identify the current water flows and procedures likely to be found in high-rise firefighting. It considers the implications of the results of the work for both the current provision of rising mains, facilities, equipment and firefighting practices in the built environment. Specifically this report considers:

1. The background and current standards for rising mains provided as part of fire and rescue service facilities.
2. The subjective performance of firefighting branches at reduced pressures against criteria based on best practice of compartment firefighting tactics.
3. The pressures available at firefighting branches when supplied from different diameters of fire hose which may be used to fight a fire from a firefighting shaft.

The main findings of the report are that:

1. The subjective performance of the firefighting branches assessed decreases with decreasing pressures.
2. There is significant variation in the pressure beneath which the subjective (from a panel of professionals) performance of firefighting branches is considered inadequate to undertake the techniques taught for compartment firefighting. The majority of branches tested required a minimum operating pressure of 4 bars at the branch to perform satisfactorily in the panel's view.
3. The techniques that are taught for compartment firefighting may not be appropriate at low pressures with some of the branches assessed. This will depend upon the size and length of hose line supplying the firefighting branch.
4. When firefighting in tall buildings fitted with dry rising mains there will be an elevation beyond which there is inadequate pressure to undertake adequate compartment firefighting techniques with some firefighting branches. This elevation will depend upon the size and length of hose used for the attack line, the flow and the specific performance of the firefighting branch used. For the same firefighting branch, where 45mm hose is used, this elevation will be significantly less than that where 70mm hose is used. If 51mm hose was used a firefighting attack could be mounted at higher elevations than could be achieved with 45mm hose currently used by most fire and rescue services.
5. When firefighting in tall buildings fitted with wet rising mains, the pressure at the riser outlet is regulated between 4 and 5 bars. Depending upon the size of the hose and the specific performance of the firefighting branch, there may be insufficient pressure available at the firefighting branch to undertake techniques that are taught for compartment firefighting. This situation will be exacerbated where smaller diameter hose is used for the attack line.
6. There appears to be limited correlation between the running pressure and flowrates specified for wet rising mains indicating that the performance criteria specified is not empirically based and should be reviewed.
7. The results highlight the fact that fire and rescue services may need to evaluate the performance of the branch types that they use during high-rise firefighting operations to comply with their obligations under Section 4 of The Provision and Use of Work Equipment Regulations. This will include other influencing factors such as the pressures available from dry/wet riser systems and the diameter and lengths of hose used.
8. Further research should be conducted into the performance standards required of both dry and wet rising mains in tall buildings to develop standards which will support the use of compartment firefighting techniques required to support the safety of firefighters. This work should also include contingency arrangements for possible failure of facilities designed to support firefighting in tall buildings.
9. The generic risk assessment for high-rise firefighting and search and rescue procedures produced by HM Fire Service Inspectorate should be revised in light of the results of this work and the future research identified.

10. Finally the report recommends that an agreed national high-rise firefighting and search and rescue procedure should be developed, which reflects:
- the type, performance and limitations of firefighting facilities provided in tall buildings,
 - the physiological limitations of firefighting and search and rescue procedures in tall buildings,
 - the performance and limitations of fire and rescue service equipment designed to support firefighting in tall buildings and
 - contingency arrangements for possible failure of facilities designed to support firefighting in tall buildings.

Background

The Building Disaster Assessment Group (BDAG) was established to consider the issues, for fire authorities and their fire and rescue services in the UK, that have been highlighted by the World Trade Centre incident of 11th September 2001. A principle aim of this group is to promote the health and safety of firefighters and building occupants by ensuring that building design reflects the operational response and practices of the fire and rescue service, and equally that operational practices reflect building design assumptions. This is particularly important when planning for extreme events such as terrorist activities.

However, the relationship between firefighting and building design when considering terrorist activity also impacts upon firefighting and building design assumptions for 'normal' activity. Current building design guidance is largely based on post war building studies and so is often based on fire and rescue service equipment and practices which are no longer in use. The building stock has also changed significantly in this period – many buildings are now based on engineering designs rather than codes and construction materials have also changed. Many firefighting and equipment procedures have changed to reflect the changing environment and the need to ensure firefighter safety.

The amount of water required to fight extreme fires in high-rise buildings is an issue that has arisen as a result of the attacks on the WTC on September 11th 2001, but which is relevant for all high-rise fire incidents. However, there is little data currently available to establish whether the current provisions and corresponding fire and rescue service procedures are appropriate. There is a pressing short-term need to ensure that firefighting techniques in tall buildings align to the equipment used by firefighters, the fixed systems provided and the supporting guidance contained in Approved Document B and British Standards. Where techniques do not align with equipment then the changes needed in either firefighting procedures, fixed equipment or the supporting guidance or standards should be identified.

1.0 Introduction

- 1.1 Firefighting shafts[†], containing rising mains, are provided to assist the fire and rescue service in accessing and fighting fires in tall buildings. The rising mains may be either dry mains supplied from a fire appliance pump, or systems which are permanently charged – wet mains. Where dry mains are provided the pressure available at the firefighting branch reduces with increasing elevation due to the static head of the water in the rising main and frictional losses. In very tall buildings these losses will ultimately exceed the pressure supplied from the fire appliance pump supplying the main. For this reason in the UK, in buildings over 60m, the mains are permanently charged to provide a pressure-regulated flow.
- 1.2 The current height at which a wet riser is required in a building may however, no longer be appropriate to ensure that adequate pressure and flow are available to meet the performance requirements of equipment currently used by fire and rescue services because:
- increased fire load or compartment size in large buildings may have increased the potential fire size,
 - compartment firefighting techniques have changed,
 - equipment specifications have changed,
 - decreased pressures from water mains may have decreased the amount of water available to the fire and rescue service.
- 1.3 These issues also hold true for firefighting from a dry riser, but are exacerbated by the drop in pressure with increased elevation in a building.
- 1.4 In addition, there is concern that internal firefighting from a firefighting shaft may not be adequate to control or extinguish a fire due to the extent of fire development at the time of fire and rescue service intervention. In particular the use of generic criteria in defining the number of firefighting shafts does not account for:
- the fire load and rate of fire growth for the particular occupancy, and
 - the time of intervention against the time of ignition of the fire (and thus its potential size and heat release).

[†] In the UK a Firefighting shaft is a protected enclosure containing a firefighting stair, firefighting lobbies and, if provided, a firefighting lift together with its machine room (BS 5588: Part 5:1991 Section 1).

1.5 These concerns suggest that there is a requirement to examine the current provision of rising mains, current firefighting practices and the facilities and equipment used when fighting a fire from a firefighting shaft. This report considers:

- The background and current standards for rising mains provided as part of fire and rescue service facilities.
- The subjective performance of firefighting branches at reduced pressures, against criteria based on best practice of compartment firefighting tactics.
- The pressures available at firefighting branches when supplied from different diameters of fire hose which may be needed to fight a fire from a firefighting shaft.

1.6 These results will be used to support:

- fire and rescue service training, equipment and procedures,
- building design guidance,
- generic and dynamic risk assessments including extreme events such as terrorism or natural disasters.

2.0 Provision of rising mains in tall buildings

- 2.1 This section details the current provision of rising mains in tall buildings made under the Building Regulations. Further information on the historical background, rationale and identification of other standards, which specify rising mains, is provided at Appendix C.

Current Requirements: Approved Document B, Fire Safety. 2000

- 2.2 Guidance on the provision of fire mains is given in Section 16 of Approved Document B to the Building Regulations. This states that:
- 2.3 *“Fire mains are installed in a building and equipped with valves etc so that the fire service may connect hoses for water to fight fires inside the building. Rising fire mains serve floors above ground, or upwards from the level at which the fire service gain access. Falling mains serve levels below fire service vehicle access level. Fire mains may be of the ‘dry’ type which are normally empty and are supplied through hose from a fire service pumping appliance. Alternately they may be of the ‘wet’ type where they are kept full of water and supplied from tanks and pumps in the building. There should be a facility to allow a wet system to be replenished from a pumping appliance in an emergency¹.*
- 2.4 Approved Document B indicates that fire mains should be provided within firefighting shafts on the basis of one fire main per shaft with the outlets from the mains being located in each firefighting lobby giving access to the accommodation².
- 2.5 The criteria for the provision of firefighting shafts are outlined elsewhere in the Approved Document³. There is however a control criterion that *“Firefighting shafts ...should be located such that every part of every storey, other than fire service access level, is no more than 60m from the fire main outlet, measured on a route suitable for laying hose. If the internal layout is unknown at the design stage, then every part of every such storey should be no more than 40m in a direct line from the fire main outlet⁴”.*
- 2.6 Approved Document B goes on to indicate that wet rising mains should be provided in buildings with a floor at more than 60m above fire service vehicle access level. In lower buildings where fire mains are provided, either wet or dry mains are suitable⁵.
- 2.7 Guidance on other aspects of the design and construction of fire mains, not included in the Approved Document, can be found in Sections 2 and 3 of BS 5306:Part 1: 1976⁶.

*BS 5306: Part 1:1976 Fire Extinguishing Installations and Equipment on Premises*⁷.

- 2.8 In addition to detailing the type of rising main to be installed in a building, the standard specifies that each pump supplying a wet riser should be capable of providing a flow of water of at least 25 litres/s (1500 litres/min) in the wet rising main. This is taken to be sufficient to serve a line of hose from three landing valves simultaneously i.e. 500 litres/minute per hose line. A minimum running pressure of 4 bar and a maximum of 5 bar should be maintained at each landing valve when any number, up to three, are fully opened⁸.

Performance Criteria for Rising Mains used in Practical Trials

- 2.9 The following performance requirements relating to rising mains were used to support practical trials outlined in Section 6 of this report.
- 1) Firefighting shafts should be located such that every part of every storey, other than fire service access level, is no more than 60m from the fire main outlet, measured on a route suitable for laying hose. Appendix C identifies other building design guidance, which use the same criteria. Delivery hose is available in various lengths⁹, of these fire and rescue services generally use hose 25m in length. A distance of 60m from a riser outlet equates to 3 to 4 lengths of hose between the riser outlet and the firefighting branch, depending on which floor the firefighting attack is mounted from and the layout of the fire floor. **It is noted that the generic risk assessment produced by HM Fire Service Inspectorate for high-rise firefighting¹⁰ advocates using 2 lengths of 45mm hose (50m in total). This does not align to the 60m control criterion for rising mains identified above and should therefore be reviewed.**
 - 2) A minimum running pressure of 4 bar and a maximum of 5 bar should be maintained at each landing valve when any number, up to three, are fully opened with a flowrate of 500 litres/min.

3.0 Compartment firefighting training and tactics

HSE improvement notice to South Wales Fire Authority, July 1996

- 3.1 Following a fire at Blaina in February 1996 at which two firefighters lost their lives, the Health and Safety Executive issued an improvement notice to the fire authority, stating that the authority was contravening the Health and Safety at Work Act, because “employees are not provided with adequate health and safety training to equip them for the risks to which they are exposed”¹¹. The improvement measures included: identifying any deficiencies in the training program in comparison with national guidance, revising the training program accordingly and developing a system of monitoring and review of the training.

*Fire Service Manual volume 2: fire service operations – compartment fires and tactical ventilation*¹²

- 3.2 Following the Blaina incident guidance was produced on actions to be taken where backdraught may be suspected, this included recommendations on the use of sprays as part of door entry procedures.
- 3.3 The recommended actions for firefighters are listed as¹³:
- check for signs and symptoms of backdraught before opening door,
 - cover the door with a charged branch if they decide to open it,
 - spray the gases building up outside the door before opening,
 - consider the option to ventilate the compartment thoroughly before entering.

Fire behaviour training instructor course

- 3.4 The Fire Behaviour Training Instructor Course at the Fire Service College (UK) has been developed to enable students to devise and deliver theoretical and practical training in flashover and backdraught, competently and safely¹⁴. Various fire and rescue services also provide practical training in compartment fire behaviour training¹⁵.

*Fire Service Manual, volume 4: fire service training, guidance and compliance framework for compartment fire behaviour training*¹⁶

- 3.5 This manual builds on previous guidance on practical training for compartment fires¹⁷ and identifies that compartment fire training facilities support the achievement of the training aims and objectives by providing opportunities for personnel to¹⁸:
- increase their understanding of fire behaviour,
 - practice firefighting techniques.

- 3.6 The manual goes on to state that practical fire behaviour and firefighter training conducted in a safe and controlled environment also allows operational personnel to contribute to their own safety¹⁹ by developing:
- confidence to deal with fires in compartments,
 - responsibility for their own performance and safety,
 - knowledge and self discipline to employ safe systems of work,
 - confidence in their team members and incident commanders,
 - confidence in their equipment, PPE and operational procedures,
 - effectiveness as a member of a team,
 - adaptability to changing circumstances,
 - vigilance for their own safety and that of colleagues,
 - recognition of their own abilities and limitations and that of their firefighting equipment and PPE.
- 3.7 Section 8.5.4 states that *"the firefighting equipment available to fire fighters participating in compartment fire training should be consistent with a risk assessment of a typical severe room fire and of a type currently in operational use by the fire brigade and therefore known to the students"* and
- 3.8 *"8.5.5 The size and type of equipment must not be reduced or scaled down or modified for CFBT purposes. This could result in the mistaken belief that circumstances trained for and on the fireground are the same."*
- 3.9 There is therefore a justifiable assumption that the techniques taught for dealing with compartment fires can be applied with the equipment used by fire and rescue services. There is also a legal requirement to ensure that the equipment used for firefighting is suitable for the purpose through The Provision and Use of Work Equipment Regulations.

The provision and use of work equipment regulations 1998²⁰

- 3.10 Section 4 of the Provision and Use of Work Equipment Regulations²¹ states in regard to the suitability of work equipment that:

"4. – (1) Every employer shall ensure that work equipment is so constructed or adapted as to be suitable for the purpose for which it is used or provided.

(2) In selecting work equipment, every employer shall have regard to the working conditions and to the risks to the health and safety of persons which exist in the premises or undertaking in which that work equipment is to be used and any additional risk posed by the use of that work equipment.

(3) Every employer shall ensure that work equipment is used only for operations for which, and under conditions for which, it is suitable.

(4) In this regulation "suitable" means suitable in any respect which it is reasonably foreseeable will affect the health or safety of any person."

- 3.11 The work undertaken for this report therefore seeks to identify (subjectively) when the techniques for dealing with compartment fires could not be applied successfully due to the pressure available at the firefighting branch.

Techniques of water application

- 3.12 Much has been written on the techniques of water application^{22, 23, 24, 25, 26}. Subject to the assessment of fire conditions, it will usually be necessary for crews to enter the fire compartment to apply these techniques to achieve control of the fire. A direct attack method where water is applied to the base of the fire is preferred for an incipient or growing unobstructed fire. An indirect attack, where water is applied to hot surfaces to produce steam to smother the flames is preferred for a post-flashover/fully developed fire²⁷.

- 3.13 These techniques have limitations^{28, 29} and Three Dimensional (3D) Water Fog Techniques are used to complement these forms of fire attack³⁰. The review of three dimensional water fog techniques for firefighting conducted by National Research Council Canada (NRC) states that the 3D water fog technique uses:

*"a combination fog nozzle to inject fine water droplets into overhead gas layers in a series of short bursts or "pulses". The objective is to suspend fine water droplets in the smoke layer to cool, inert and dilute unburned hot gases, bringing them outside their flammability range in an attempt to prevent or quench subsequent ignitions."*³¹

- 3.14 NRC further identified that:

*"the optimum performance of the 3D water fog technique is determined by the characteristics of the water spray (e.g., droplet size and velocity, spray angle, flowrate, etc.), application technique (e.g., discharge angle, and duration of burst discharge), and fire conditions (e.g., fire size and compartment geometry)"*³².

- 3.15 The work undertaken for this report sought to investigate:

- a minimum (subjective) pressure required for firefighting branches to produce an effective spray and jet pattern, to undertake the techniques of water application identified above.
- if the techniques for dealing with compartment fires could not be applied due to the lower pressures available at the firefighting branch when re-creating a simulated firefighting attack in a tall building.

- 3.16 Whilst this report studied the use of equipment in a tall building, the same limitations would apply at reduced pressures in other circumstances.

- 3.17 Intuitively the pressure available at the firefighting branch will influence the characteristics of the spray and jet produced. The pressure and flow at a firefighting branch can be accurately assessed. However there are considerable practical and technological difficulties, as well as substantial costs, in attempting to accurately assess aspects such as size and velocity of droplets in the spray and jet patterns produced from firefighting branches. Also when considered against the skill of water application by firefighters, the quantitative significance of these factors is unknown.
- 3.18 Therefore to provide a comparative pragmatic analysis of the effect of pressure on the spray and jet characteristics produced at a range of pressures, subjective criteria based upon the professional opinion of a stakeholder panel was used. The determination of the subjective criteria and the testing methodology is outlined in Section 4.

4.0 Development of subjective criteria

- 4.1 A professional panel was established and their initial role was to determine appropriate criteria against which a branch is assumed to be operating safely/effectively. The panel consisted of representatives from the Fire Service College, Chief and Assistant Chief Officers Association/London Fire Brigade and members of the Fire Statistics and Research Division. Her Majesty's Fire Service Inspectorate was involved with initial meetings about the format of the trials but was not present at the trials.
- 4.2 The panel spent a day at the Fire Statistics and Research Division's Still Air Facility at Hangar 97, Upper Rissington (formerly RAF Little Rissington, UK) conducting branch trials. The testing arrangements are outlined in Section 5.
- 4.3 The branches evaluated were those that the Fire Experimental Unit (FEU) previously appraised in early 2000, the results of which were published as a set of data sheets³³. A list giving details of all the branches tested is given in Appendix A. In addition, an Akron Marauder branch was included which is still in use in some fire and rescue services. A further branch, the TA Incentive Group's 'Fogfighter', was evaluated at a later date. This branch is used extensively at the Fire Service College for compartment firefighting and training. The purpose of the preliminary series of trials was to determine:
- 1) Subjective criteria, which would be used to appraise the performance of the firefighting branches at different pressures.
 - 2) The settings at which the branches would, in the subjective opinion of the panel, give the most effective and favourable conditions for firefighting.
 - 3) The pressure at which the branches tested achieved the subjective criteria.
- 4.4 In establishing the subjective criteria which would be used to appraise the performance of the firefighting branches at different pressures, the panel decided firefighting branches were required to produce:
- An effective jet, as this would be required to undertake a direct fire attack.
 - An effective spray on full cone, as this would be required to provide a defensive spray to protect firefighters should it be necessary to withdraw from a compartment if the conditions deteriorated.
 - An effective spray pattern at a 70° cone angle, which would be required to undertake 3D gas cooling. This angle was chosen as being within the 60° to 75° optimum range that is recommended by other research work that has been undertaken into compartment firefighting^{34, 35, 36}.
- 4.5 These functional requirements were therefore used as the assessment criteria for the full testing of the branches outlined in Section 5 and 6 of this report.

- 4.6 In assessing branch performance against these criteria, the panel decided that the branches would be set to the maximum cone angle and maximum flowrate setting where applicable, as these settings appeared to produce the most favourable conditions for the assessment. This rationale was therefore used for the further trials outlined in Section 5 and 6 beneath.
- 4.7 As discussed in Section 8 later a number of branches were not assessed, as the panel considered they were not appropriate for compartment firefighting. Where branches were excluded from the testing the branch number is indicated on the subsequent Figures but no data is recorded for pass pressure and flowrate for those branches.
- 4.8 The preliminary trials determined the minimum operating pressures (known as 'pass pressure' from here on) for the branches to achieve the subjective criteria. No other measurements were taken during this initial set of trials.
- 4.9 A subsequent series of trials was conducted where detailed measurements of the jet/spray characteristics were recorded. These trials are described in Section 5 including details of the testing arrangement and results for the preliminary and subsequent testing undertaken.
- 4.10 It should be noted that for the reasons outlined above, the spray patterns of the branches were assessed purely on a qualitative basis. Should accurate and cost effective full-scale techniques be developed in the future that can assess the spray characteristics of branches it would be worthwhile conducting a quantitative analysis on the performance of branches at different pressures.

5.0 Branch performance trials

Background

The trials were designed to provide measurements of the spray patterns, jet throw and the flow versus pressure characteristics of each branch and to identify a minimum subjective pressure for effective operation. To achieve this each branch in turn was mounted horizontally in a rig and examined under similar conditions, the hydraulic configuration of the testing undertaken is outlined in Section 5.7.

Definitions of terms

- 5.1 The definitions of the terms used in the testing are illustrated in Figure 1 and described beneath
- 5.2 The “throw” of a jet was taken as the distance, measured horizontally along the floor, from the point directly below the branch coupling to the point where most water was judged by observers to fall.
- 5.3 The “width” of a jet was taken as the dimension of the area where water was falling on the floor, measured normal at ninety degrees to the jet centre line at the stated “throw”.
- 5.4 The “breadth” of a spray pattern was taken as the maximum dimension of the area where water was falling on the floor, measured normal at ninety degrees to the branch centreline.
- 5.5 The “range to breadth” of a spray pattern was taken as the length, measured horizontally along the floor, from the point directly below the branch coupling to the stated breadth”.

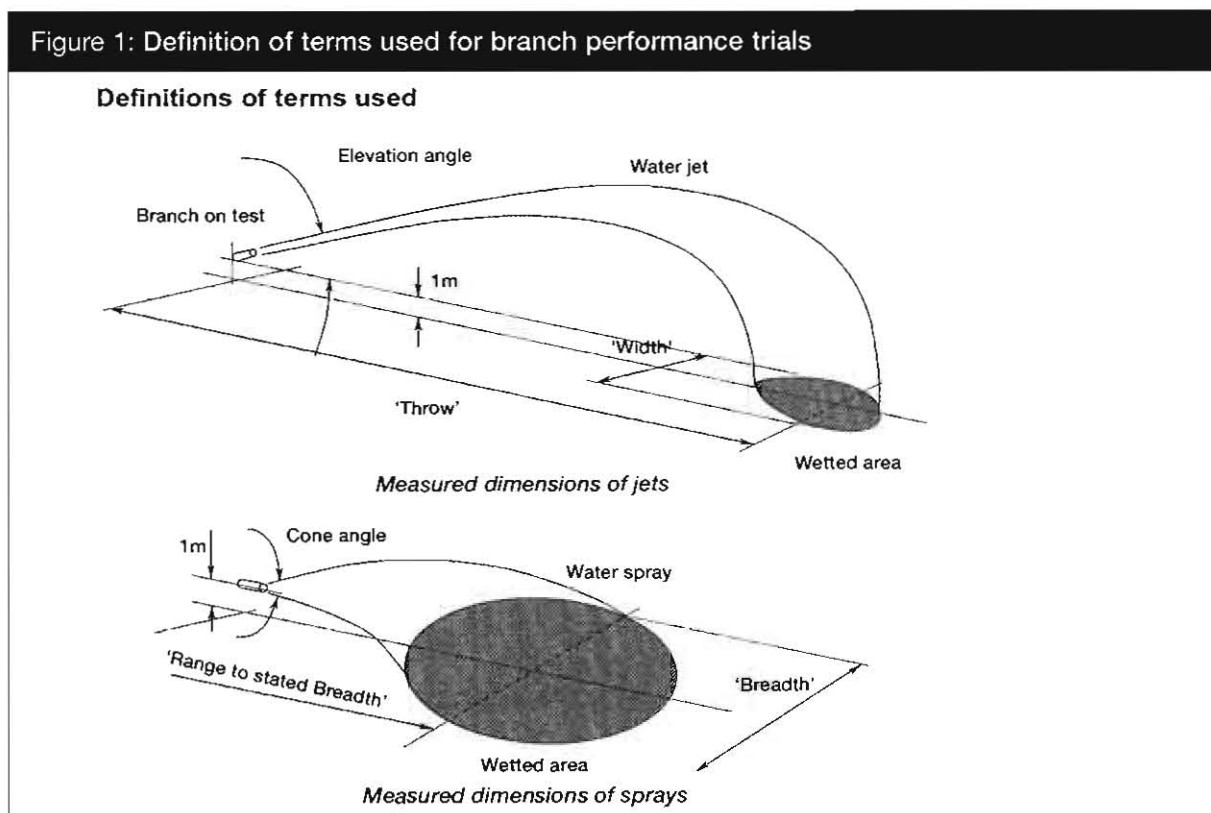

Description of hydraulic arrangement

5.6 The experimental set up is shown schematically in Figure 2.

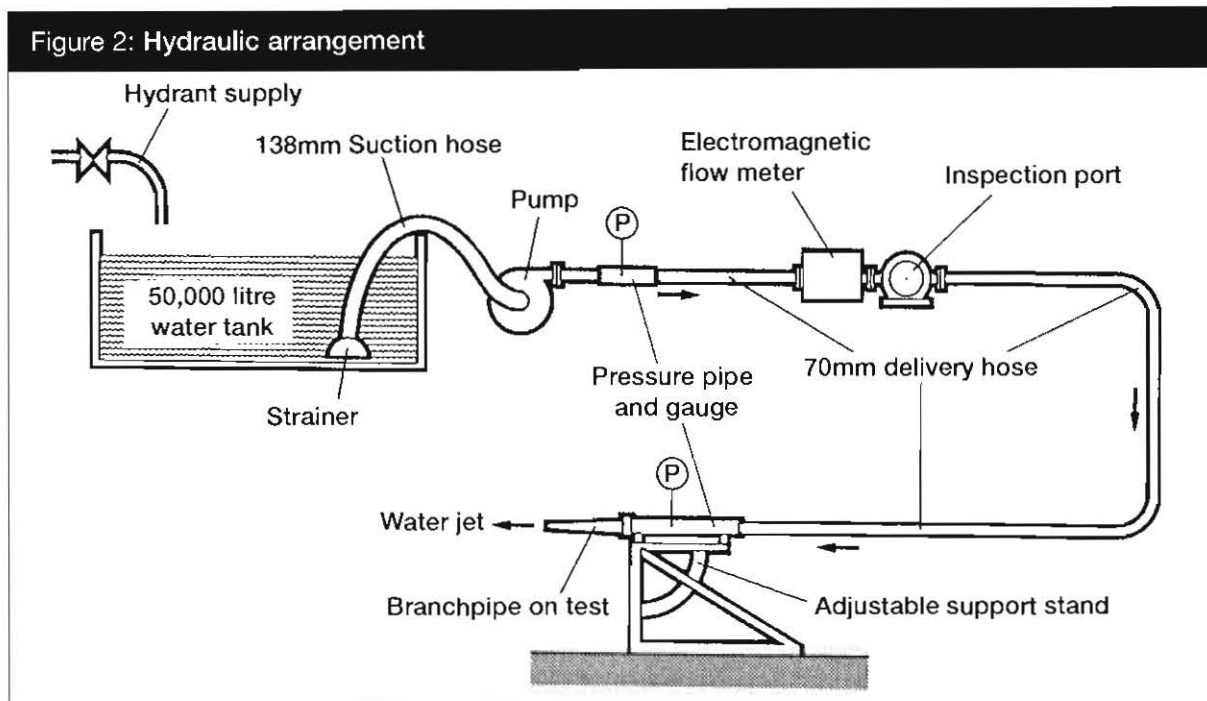

- 5.7 A hydrant supply was fed into the static tank to prevent it from becoming completely drained during the trials.
- 5.8 Water was drawn from the tank, through a strainer and 138mm suction hose into the pump. The pump outlet was connected via a 2m length of 70mm delivery hose to a pressure pipe. This in turn was connected by a 2m length of 70mm hose to the electromagnetic flowmeter (with digital readout) and glass sided inspection port and valve. This was installed as a precaution to indicate possible entrained air, which might affect the flow meter reading. Any air that was entrained was vented by use of the valve attached to the port.
- 5.9 From the inspection port another length of 6m of 70mm hose was connected to a pressure pipe which was mounted horizontally at a height of 1m from the floor in the branch support stand. The branch under test was then connected into the other end of the pressure pipe.
- 5.10 The two pressure pipes incorporated four tappings according to the “triple T” method and were connected to pressure gauges. These pressure gauges allowed the pressures at the pump and at the branch to be recorded.
- 5.11 A large protractor mounted on a stand was used to determine the cone angles of the various sprays. By sighting against a horizontal spray, half of the included angle was determined, and the cone angle calculated.
- 5.12 For measurements of “throw” and spray “breadth”, nylon measuring lines were prepared with plastic markers secured at 1m intervals. For measurements of jet “width”, a 3m length of steel was marked in 0.1m intervals.

5.13 A digital camera was used to take digital images of the jet/spray patterns. Examples of jet/spray patterns are shown as Figure 3 beneath.

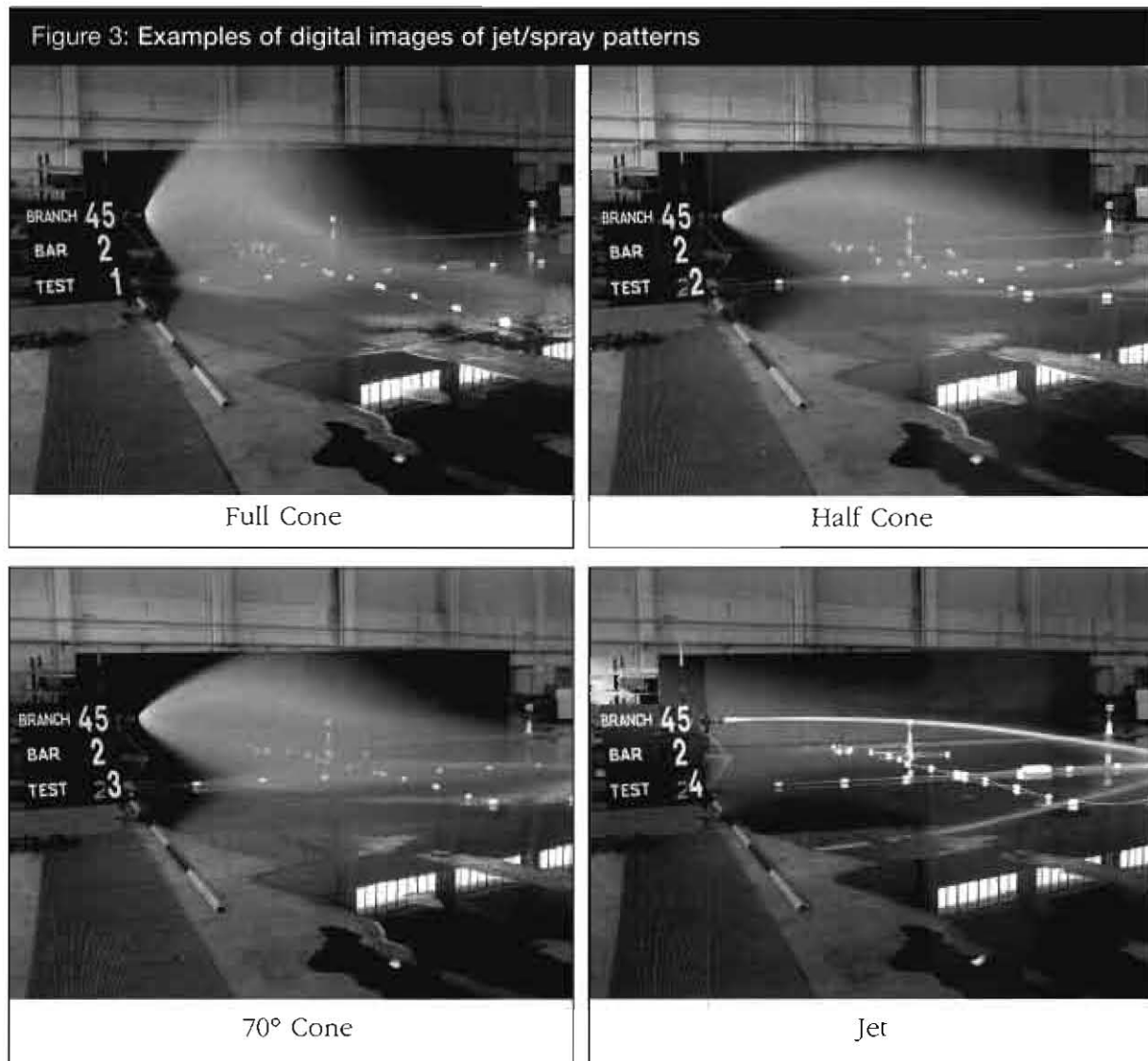

Criteria used for evaluation trials

5.14 The criteria used for the trials were those developed by the panel, as described in paragraph 4.4.

Experimental method for initial trials

5.15 For the initial evaluation trials, each branch under test was mounted horizontally in the branch support stand and was set to its maximum cone angle and maximum collar/stirrup setting where appropriate. The branch was operated over a range of increasing branch pressures starting at 1 bar. The preliminary trials showed that jet properties were not considered to be a problem at low pressures. The limiting factor in most instances was the performance of the spray pattern produced at full cone angle.

- 5.16 The panel then decided the subjective point at which the spray would not be effective or safe to use when firefighting, in their professional judgement (i.e the 'pass pressure'). This enabled the minimum operating branch pressure and corresponding flowrate to be recorded for each branch. No measurements of "throw", "breadth" or "range to breadth" of the jet/spray patterns were recorded at this time.

Full branch performance trials

- 5.17 Following the initial assessment a separate series of trials was undertaken to record detailed measurements of the jet/spray characteristics at the minimum pressures required for the branches to achieve the assessment criteria.
- 5.18 Comprehensive measurements of the sprays and jets had already been made at 3, 5 and 7 bar for the branches detailed in the earlier FEU work. However, to supplement these results, where data had not previously been recorded, measurements of full, half and 70° cone angles and jet were taken with the branches set to the pressure at which the branch attained the subjective criteria set by the professional panel.

Experimental method for full branch performance trials

- 5.19 Each branch was mounted horizontally in the branch support stand and set to the required cone angle (full, half, 70°) or jet setting. Half and 70° cone angle were set using the large protractor.
- 5.20 The pressure at the branch was then set, as determined by the professional panel, using the pressure gauge. Two experimenters, then made measurements of throw, breadth, or range to breadth as appropriate using the nylon measuring lines. The pump operator recorded branch pressure and flowrate. The data obtained is provided at Appendix B. Digital images of the jet/spray patterns were taken using a digital camera examples of which are shown as Figure 3 above.
- 5.21 This process was repeated for all collar/stirrup settings available on the branch where appropriate.

6.0 Combining branch performance with firefighting attack from a rising main

- 6.1 A firefighting attack may be mounted from either a dry or a wet rising main depending upon the height of a building. A dry rising main will have a variable pressure output due to hydraulic losses which increase proportionately with the elevation in the building. Therefore to limit this variability within the trials, the pressure outputs and performance criteria for a wet rising main were used as these are a known regulated standard.
- 6.2 Section 2 identified the following performance requirements relating to rising mains:
- a) Firefighting shafts should be located such that every part of every storey, other than fire service access level, is no more than 60m from the fire main outlet, measured on a route suitable for laying hose.
 - b) A minimum running pressure of 4 bar and a maximum of 5 bar should be maintained at each landing valve when any number, up to three, are fully opened with a flowrate of 500 litres/min.
- 6.3 The performance criteria in 6.2 a) and 6.2 b) were therefore integrated into a second phase of experimental trials. The aims were to establish:
- a) If the performance criteria for the firefighting branches defined by the professional panel could be attained when simulating connection of a 69m hose line to a wet riser running at 4 to 5 bars pressure.
 - b) If there was correlation between the flowrate of 500 litres/min to the simulated connection of a 69m hose line to a wet riser running at 4 to 5 bars pressure through 45mm and 70mm hose lines supplying the branches under evaluation.
- 6.4 Fire and rescue services in the UK typically use hose lengths of 25m, although this can vary significantly as hose which is repaired often reduces in length, but remains in service. Therefore to reach up to 60m from a riser outlet would, depending on the floor layout, require the connection of three lengths of hose. However substantial fires would need to be tackled from the floor below the fire floor which would necessitate up to four lengths of hose.
- 6.5 The two main sizes of delivery hose used in the UK fire and rescue services are 45mm and 70mm³⁷. To assess if there was any significant affect upon performance due to the choice of hose size comparative measurements of pressures and flows were taken with hose lines of each diameter.

- 6.6 Using hose from FEU stock an overall length of 69m was used in these tests. This was the nearest to the 75m that three new lengths of hose would cover, but reflective that the performance criteria from a riser outlet was less than 75m and that, in practice, hose is often shorter than the ideal length. For the 45mm hose line this consisted of 3 lengths of 18m and one length of 15m. These were connected between the inspection port and the pressure pipe mounted in the branch support stand.
- 6.7 In the case of the 70mm hose a total length of 69m of hose was used again which consisted of 3 lengths of 23m.

Experimental method

- 6.8 Each branch under test was mounted horizontally in the branch support stand and was set to its maximum cone angle and maximum collar/stirrup setting where appropriate.
- 6.9 The 69m of 45mm hose was connected from the inspection port to the pressure pipe in the branch support stand. The pressure at the pump was set and recorded at 4 bar (to simulate the 4 bar at the outlet of the riser), then branch pressure and flowrate were recorded. The process was then repeated at 5 bar pump pressure.
- 6.10 Once measurements for all the branches had been recorded the 45mm hose was replaced with 69m of 70mm hose and the whole process was repeated again.
- 6.11 It should be noted that branches numbers 51, 54 and 59 are not designed to operate below 6 or 7 bar respectively. Although it was known that they would not pass this additional evaluation, as they were designed for higher operating pressures than are supplied by a wet rising main, they were included for completeness.
- 6.12 To assess whether there was a correlation between the performance requirement of 500 litres/min and the pressure regulation of 4 to 5 bars at the riser outlet a test series was also conducted using these criteria. In this instance the same configuration of 45mm and 70mm hose lines were used. The appliance pump pressure was then adjusted to attempt to generate a flowrate of 500 litres/min with the branches under evaluation and recordings made of the pressure at which a flowrate of 500 litres/min was generated. For safety reasons in attempting to generate the prescribed flow, the maximum pressure during the test was limited to 9 bars.

Use of 51mm diameter hose

- 6.13 Following completion of the above section of the work using 45mm and 70mm hose, it was decided that the performance of an alternative hose size should also be investigated. A hose was required that offered the benefits of increased pressures at the branch over 45mm hose but had reduced weight and improved manual handling compared to 70mm hose. (The physiological and logistical issues of using 70mm hose are described in paragraph 8.5).
- 6.14 After discussions, hose of 51mm diameter was selected, which although commercially available does not appear to be in use in the UK Fire and Rescue Service, although it is used within the United States. Testing using three lengths of 23m of 51mm hose was carried out as described in 6.9 and 6.12 above and the results are included in Section 7 with those of the 45mm and 70mm hose.

7.0 Results

Results from Branch Performance Trials

7.1 Appendix B gives details all of the measurements taken from the branch performance trials.

Subjective minimum pass pressures defined by the professional panel

7.2 Results from the professional panel's evaluation of the pressure necessary to attain the performance criteria described in 4.4 are given as Figure 4 below, together with the corresponding flowrate for the branches evaluated.

7.3 It is observed that there is a significant variance in the minimum pressure required to produce a minimum effective performance sought by the panel. This ranged from 2 bars (branches 45, 48, 53, 68) through to 7 bars (branches 51, 54, 70). The majority of branches tested required 4 bars at the branch to produce an adequate performance in the view of the panel.

7.4 The flow rates obtained at the minimum pass pressures also varied significantly, from 150 lpm at 4 bars (branch 46) up to 702 lpm at 7 bars (branch 54).

7.5 The variation in the minimum pass pressure and flows produced by the branches, and the implications for the choice of equipment when firefighting using fixed installations, is discussed in Section 8.

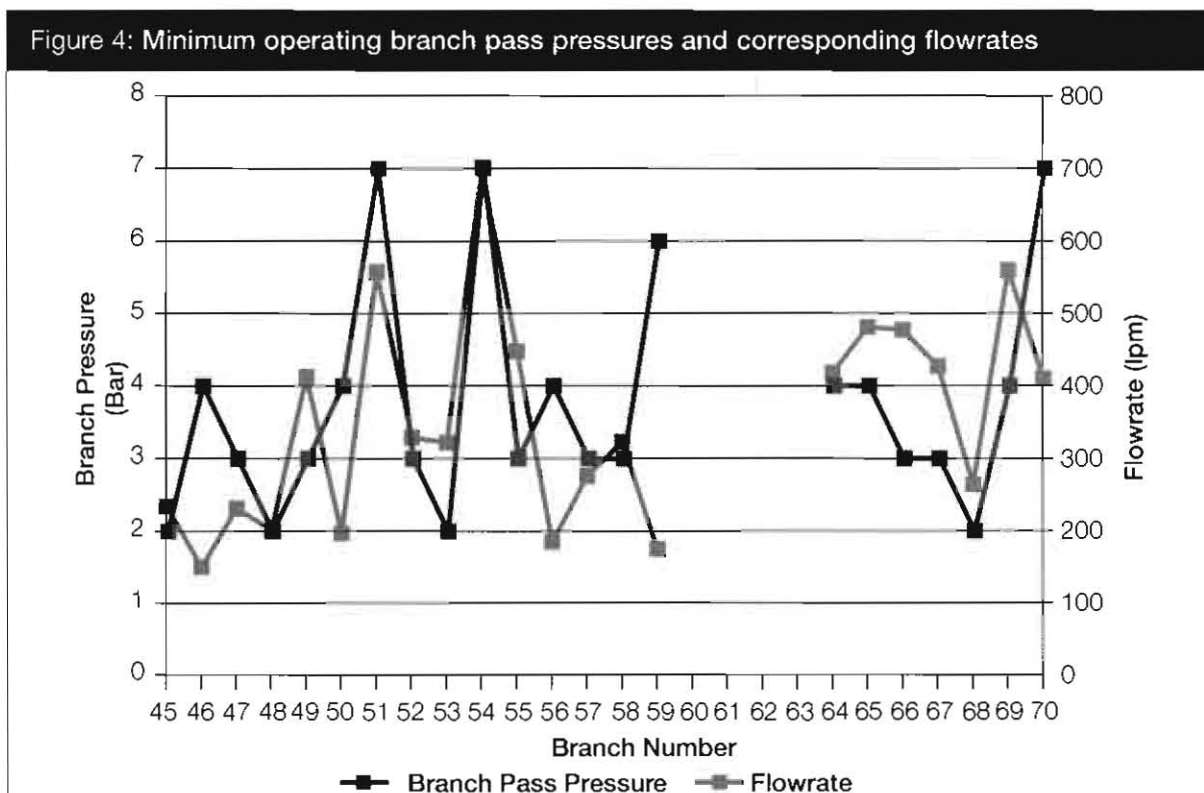

Note: Branches 60, 61, 62 and 63 were not tested as they were not felt appropriate for compartment firefighting and have therefore not been included.

Results from combining branch performance with firefighting attack from a rising main using 45mm hose

7.6 Results from the simulated use of a firefighting branch supplied from a wet riser using 45mm hose are given in Figures 5 and 6, for 4 and 5 bars running pressure respectively.

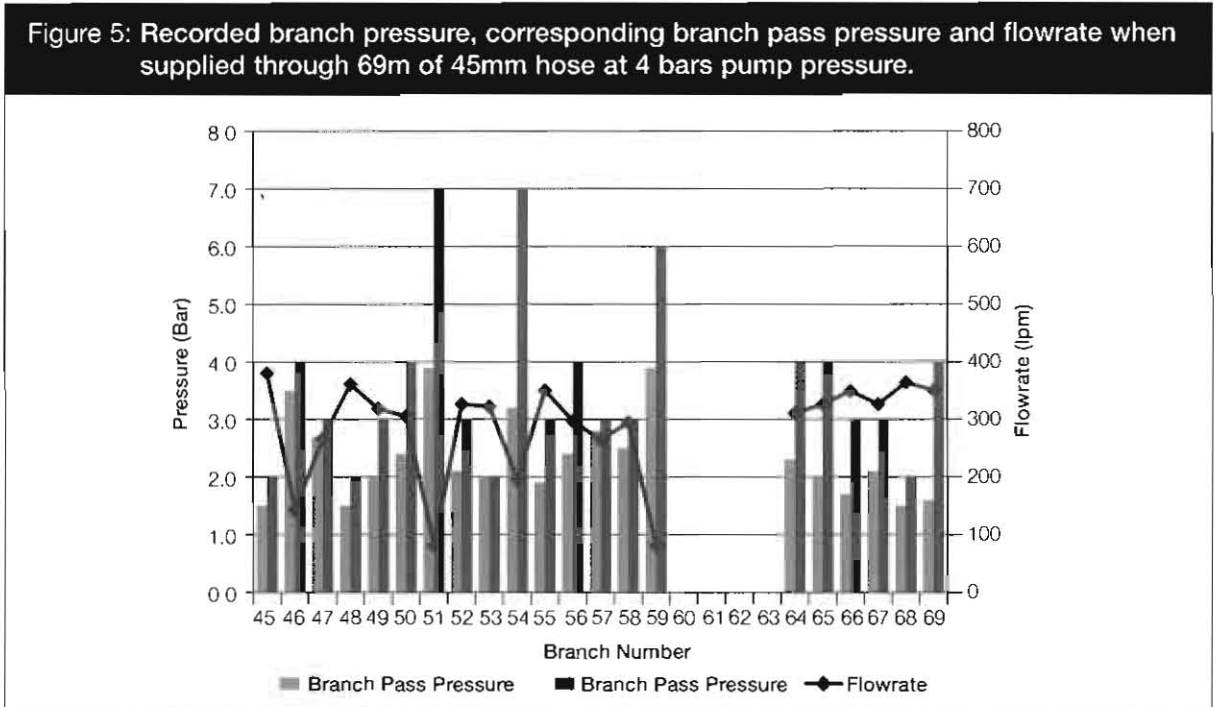

7.7 Of the branches assessed only one branch (branch 53) attained a branch pressure equal or greater than the pass pressure required for the branch (with a corresponding flowrate of 322 lpm).

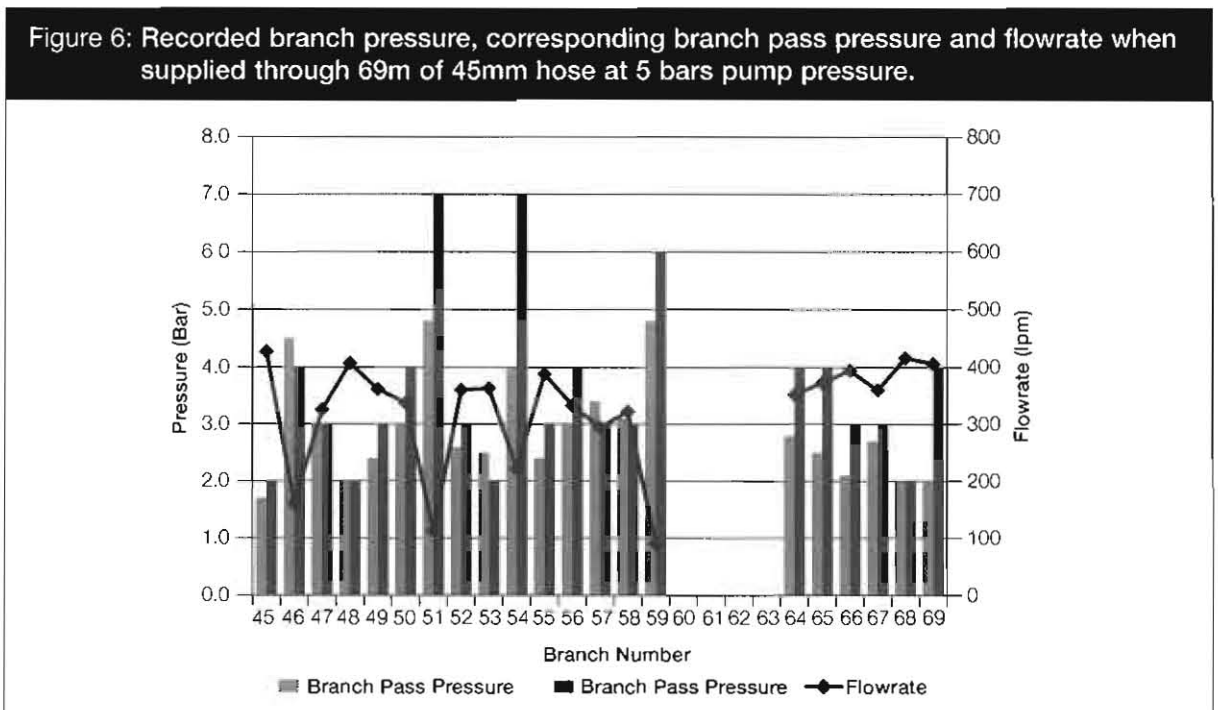

7.8 At 5 bars pressure branches 46, 47, 48, 53, 57, 58 and 68 attained a branch pressure equal or greater than the pass pressure required for the branch (flowrates ranged from 161 to 416 lpm).

Results from combining branch performance with firefighting attack from a rising main using 51mm hose

7.9 Results from the simulated use of a firefighting branch supplied from a wet riser using 51mm hose are given in Figures 7 and 8, for 4 and 5 bars running pressure respectively.

Figure 7: Recorded branch pressure, corresponding branch pass pressure and flowrate when supplied through 69m of 51mm hose at 4 bars pump pressure

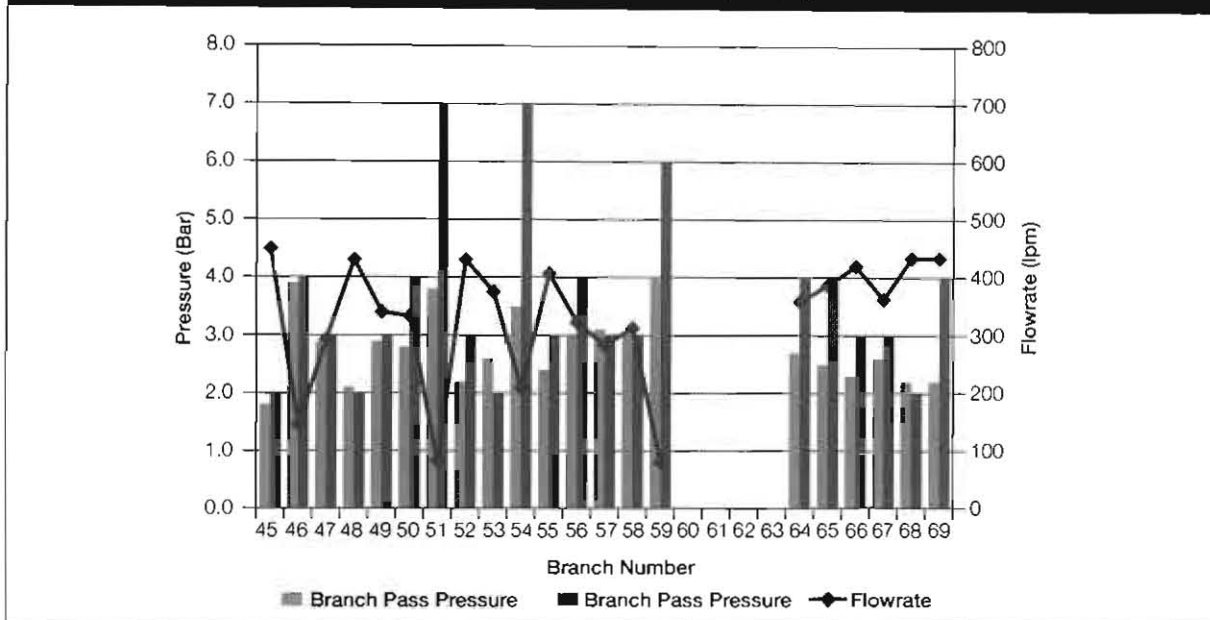

7.10 At 4 bars pressure branches 48, 53, 57, 58 and 68 attained a branch pressure equal or greater than the pass pressure required for the branch (flowrates ranged from 283 to 433 lpm).

Figure 8: Recorded branch pressure, corresponding branch pass pressure and flowrate when supplied through 69m of 51mm hose at 5 bars pump pressure

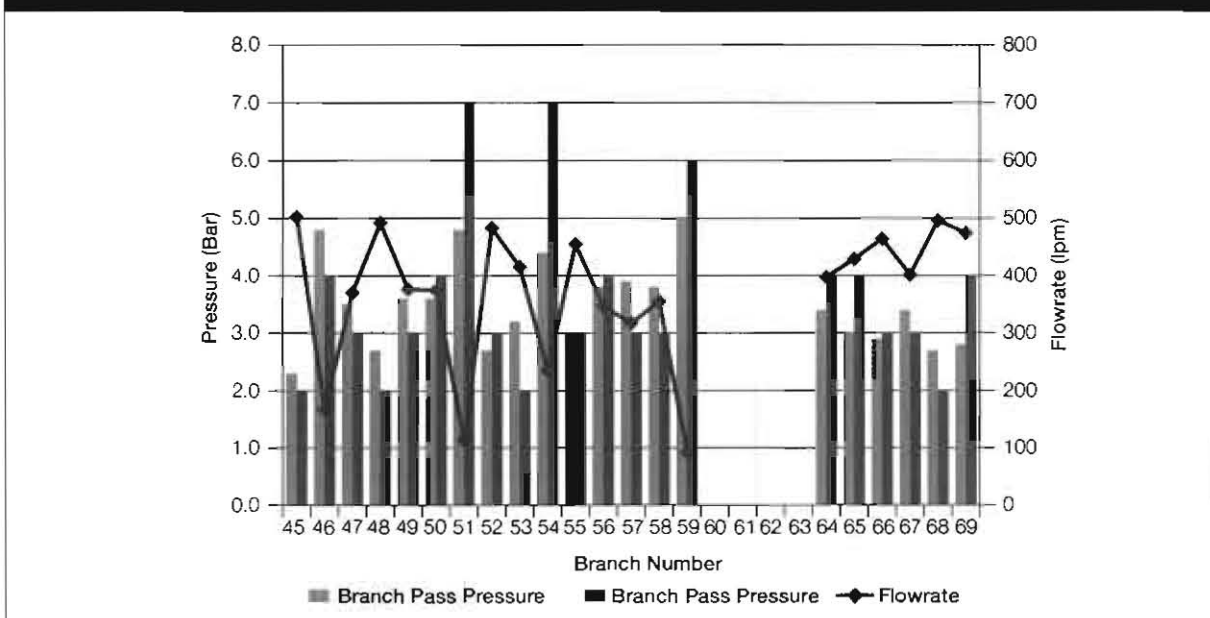

7.11 At 5 bars pressure branches 45, 46, 47, 48, 49, 53, 55, 57, 58, 67 and 68 attained a branch pressure equal or greater than the pass pressure required for the branch (flowrates ranged from 167 to 502 lpm).

Results from combining branch performance with firefighting attack from a rising main using 70 mm hose

7.12 Results from the simulated use of a firefighting branch supplied from a wet riser using 70mm hose are given in Figures 9 and 10, for 4 and 5 bars running pressure respectively.

Figure 9: Recorded branch pressure, corresponding branch pass pressure and flowrate when supplied through 69m of 70mm hose at 4 bars pump pressure.

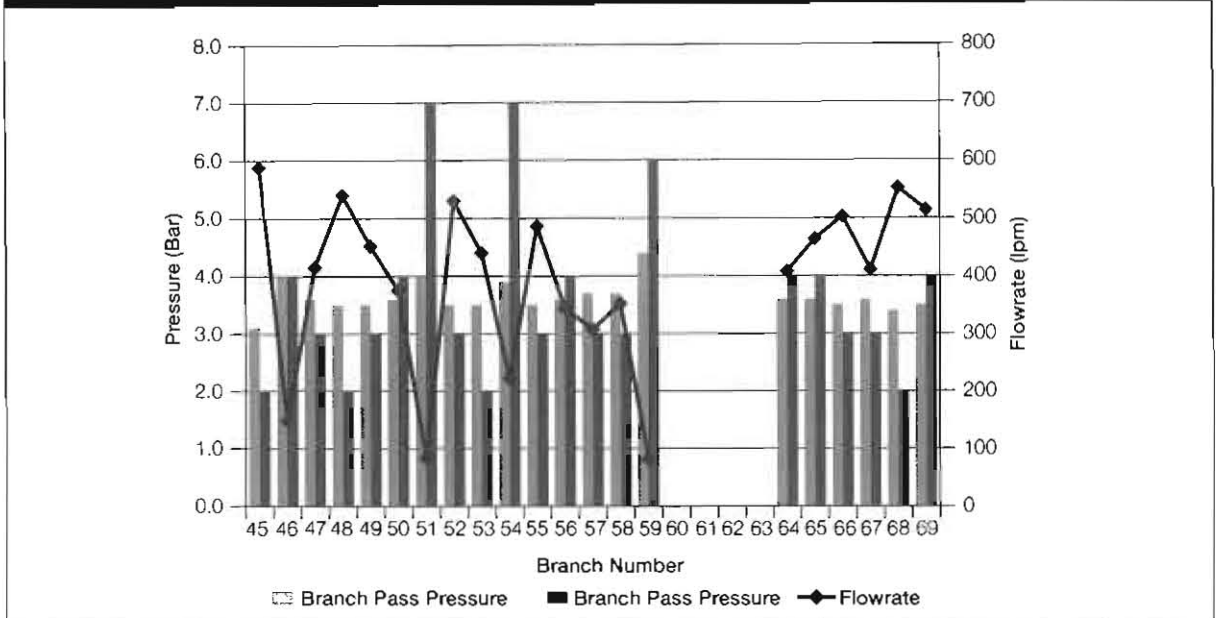

7.13 At 4 bars pressure branches 45, 46, 47, 48, 49, 52, 53, 55, 57, 58, 66, 67, and 68 attained a branch pressure equal or greater than the pass pressure required for the branch (flowrates ranged from 148 to 588 lpm).

Figure 10: Recorded branch pressure, corresponding branch pass pressure and flowrate when supplied through 69m of 70mm hose at 5 bars pump pressure.

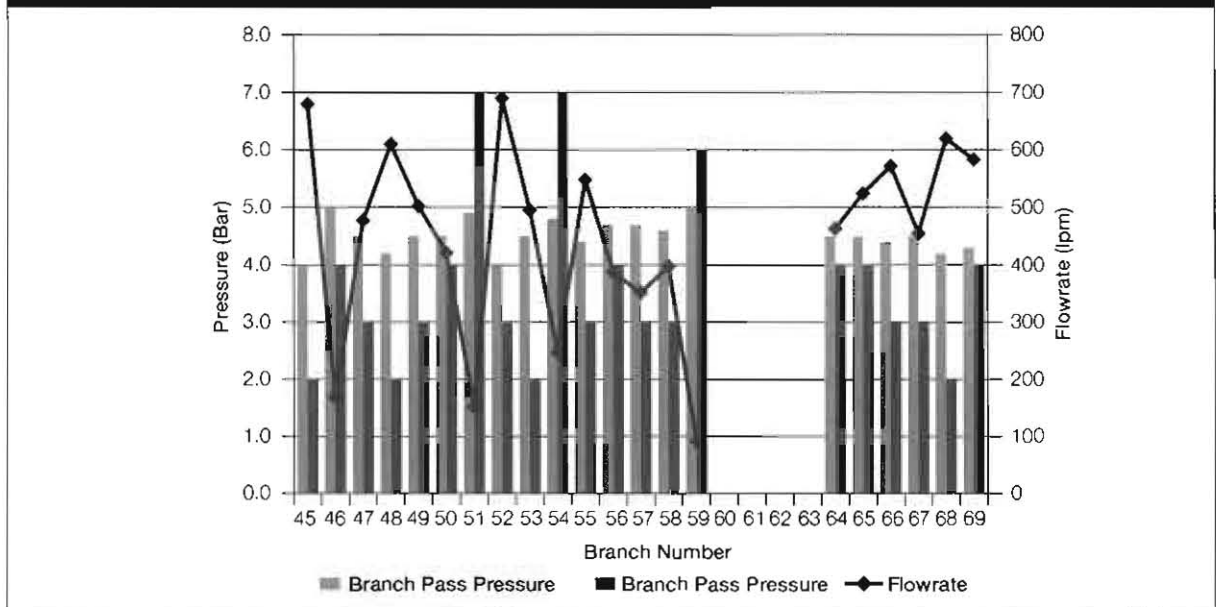

7.14 At 5 bars pressure branches 45, 46, 47, 48, 49, 50, 52, 53, 55, 56, 57, 58, 64, 65, 66, 67, 68 and 69 attained a branch pressure equal or greater than the pass pressure required for the branch (flowrates ranged from 169 to 690 lpm).

Measurements of requirement of 500lpm from a rising main using 69m of 45, 51 and 70 mm hose

7.15 The results of the pressure required to generate a flow of 500 litres/min through 45mm, 51mm and 70mm hose lines 69m in length are given as Figures 12, 13 and 14 respectively. Where a flow of 500 litres/min was not generated the resultant flow at the maximum test pressure (9 bar) is recorded.

Figure 11: Pressure required to generate a flow of 500 litres/min through 69m of 45mm hose with branches under assessment

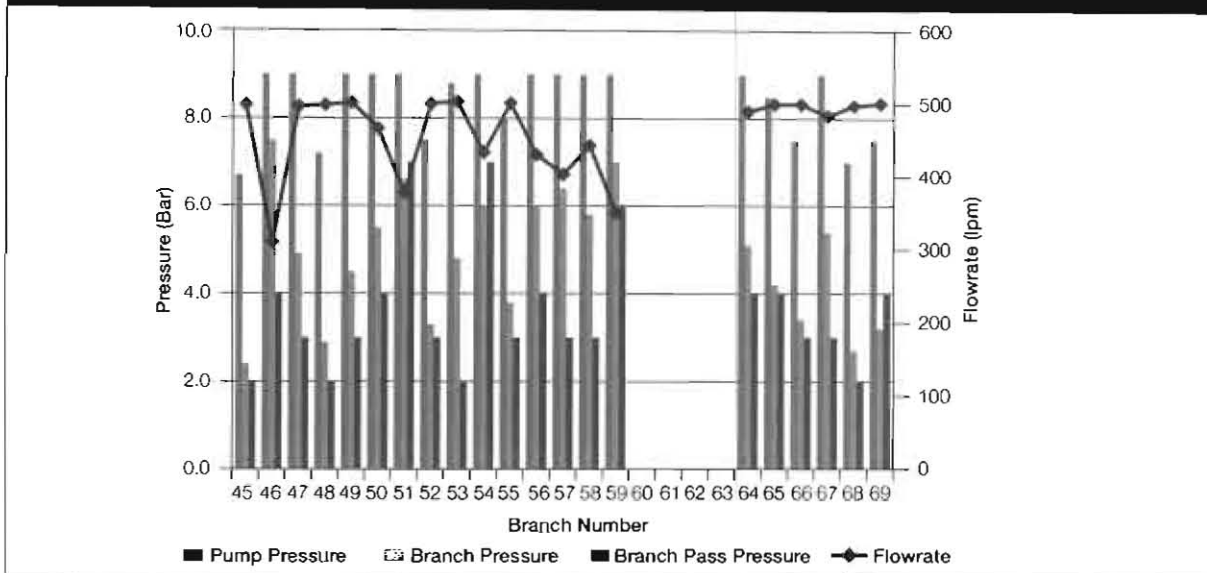

7.16 This shows branches 45, 47, 48, 49, 52, 53, 55, 65, 66, 68, 69 all achieved the required flowrate of 500lpm at pump pressures pressures ranging from 6.7 to 9.0 bar. The remaining branches would be able to achieve a flowrate of 500lpm but these would require in excess of 9 bar pump pressure.

Figure 12: Pressure required to generate a flow of 500 litres/min through 69m of 51 mm hose with branches under assessment

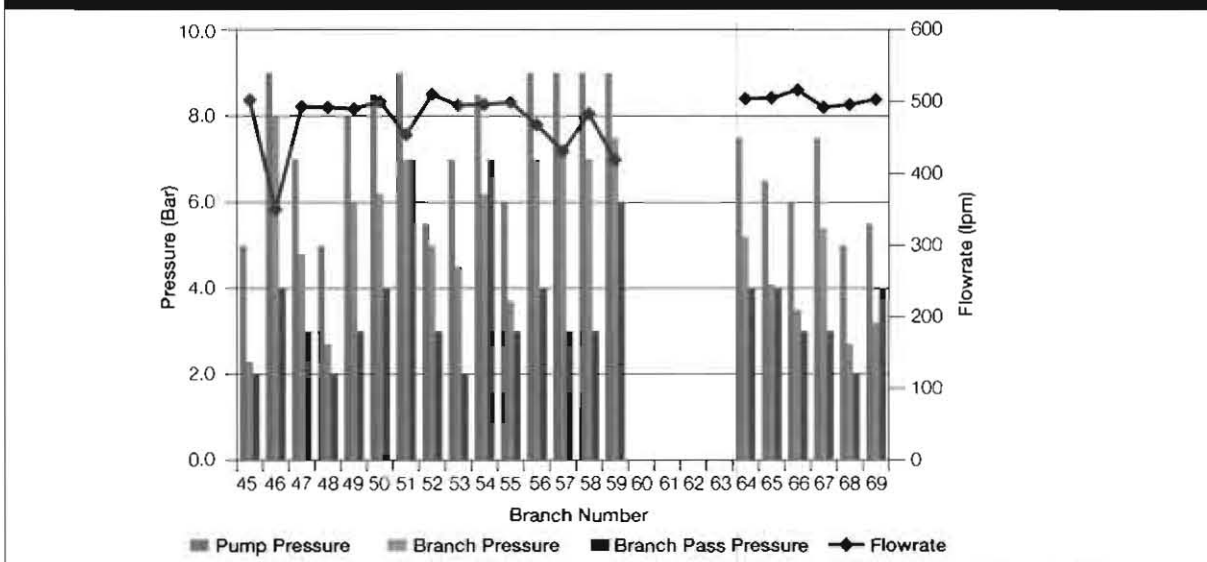

7.17 This shows branches 45, 47, 48, 49, 50, 52, 53, 55, 64, 65, 66, 67, 68, 69 all achieved the required flowrate of 500lpm at pump pressures pressures ranging from 5.0 to 9.0 bar. The remaining branches would be able to achieve a flowrate of 500lpm but these would require in excess of 9 bar pump pressure.

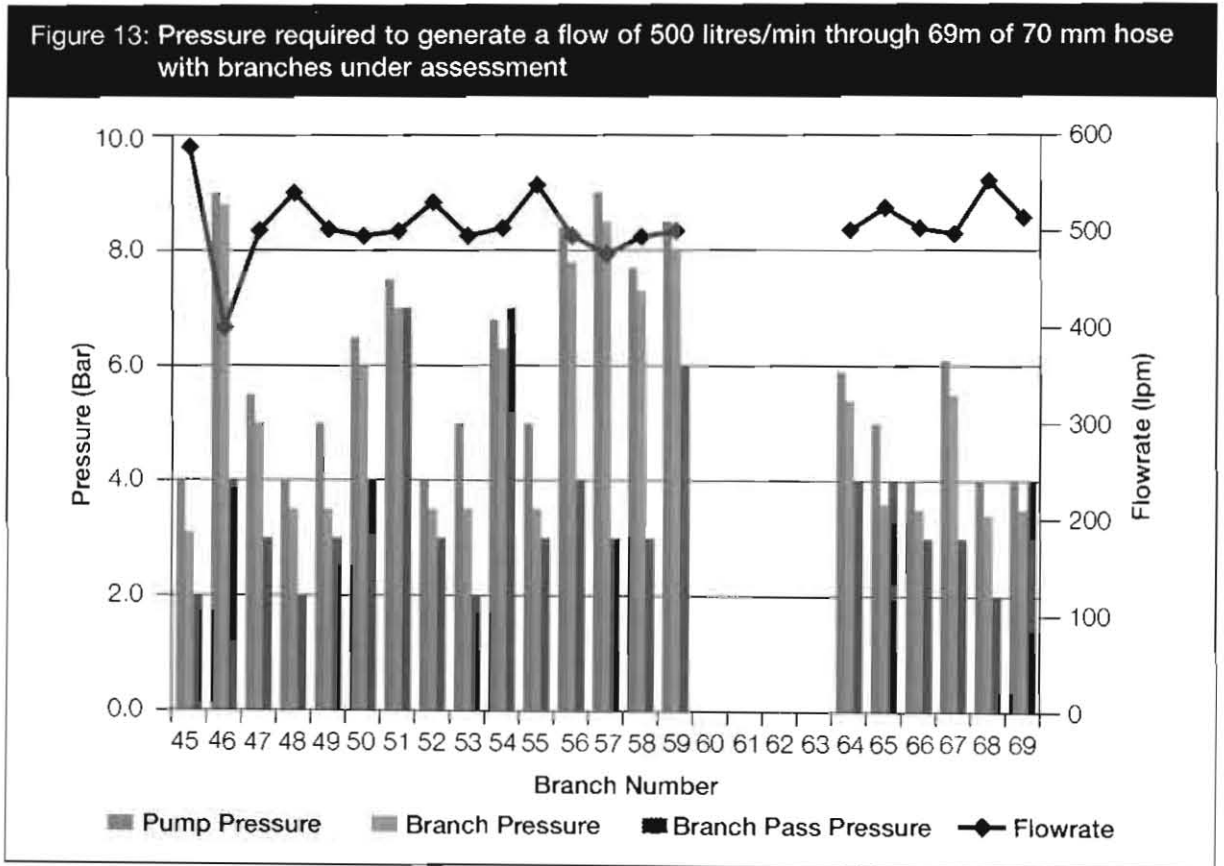

7.18 This shows branches 45, 47, 48, 49, 50, 51, 52, 53, 54, 55, 56, 58, 59, 64, 65, 66, 67, 68, 69 all achieved the required flowrate of 500lpm at pump pressures ranging from 4.0 to 8.5 bar. The remaining branches would be able to achieve a flowrate of 500lpm but these would require in excess of 9 bar pump pressure.

8.0 Discussion of results

Results from the professional panel

8.1 **The results highlight the wide variation in hydraulic performance of the branches tested. For the majority of the branches tested to attain the performance criteria set by the panel a minimum operating pressure of 4 bars at the branch would be required.** This does not however account for branches which are designed to operate at 6 or 7 bar pressure at the branch.

Branches not meeting the minimum subjective criteria

8.2 Of the 27 branches assessed by the professional panel, 4 were not subject to full testing as they were not deemed appropriate for compartment firefighting. Of those assessed 1 was deemed to not meet the minimum criteria. The reasons for this assessment are given below and in Table 1:

- The Akron Marauder produced a spray pattern that had gaps in it at all tested pressures (a 'fingered' appearance). The panel concluded that this may not provide sufficient protection for the firefighter against the effects of radiated heat. Further quantitative measurements may be needed to confirm this conclusively.
- Branches 60, 61, 62 & 63 were not considered by the panel to be appropriate for compartment firefighting. These branches were either not designed to produce a controllable pulse spray or their design did not facilitate the techniques required for compartment firefighting.

Table 1: Details of branches not meeting the minimum subjective criteria

Branch Number	Manufacturer & Description	Comments
26	Akron Brass. Marauder Style 4516	'Fingered' appearance of the spray at all pressures
60	Hughes Noble. BP1	Not tested – Not appropriate/designed for compartment firefighting (no pulse spray capability)
61	Hughes Noble. BP1-FR	Not tested – Not appropriate/designed for compartment firefighting (no pulse spray capability)
62	Hughes Noble. Powerjet NPJ7	Not tested – Not appropriate/designed for compartment firefighting (no pulse spray capability)
63	AWG. M2540 16mm Nozzle	Not tested – Not appropriate/designed for compartment firefighting (no pulse spray capability)

Branches meeting the minimum subjective criteria

- 8.3 A total of 22 branches passed the professional panel's minimum criteria at pressures ranging between 2 to 7 bars. The flowrates for these branches ranged between 150 and 702 lpm. This range of flowrates would have a significant effect on the size of fire which could be tackled using direct and indirect forms of attack. It should be noted however that at low pressures kinking of the hose line is likely to occur. This may have a significant effect upon the water supply and pressure available at the firefighting branch.

Results of combining branch performance with firefighting attack from a rising main

- 8.4 **For the vast majority of the branches evaluated the results indicate that when using 69m of 45mm or 51mm hose the performance standard of a minimum 4 bars running pressure for a wet rising main is not sufficient to attain the subjective criteria of compartment firefighting identified by the professional panel.** The upper running pressure of a wet rising main at 5 bars is not sufficient for the majority of the branches to perform adequately, in the panel's view, when using 69m of 45mm or 51mm hose. The situation would be exacerbated for both limits where a fire was tackled from the floor below the fire floor (see 8.6 below).
- 8.5 Other than for branches designed to operate at 6 or 7 bars, where larger 70mm diameter hose is used, the running pressure of 5 bars for a wet rising main is adequate. At the lower running pressure of 4 bars the number of branches which are able to attain the subjective criteria decreases. This is not unexpected, as frictional loss is inversely proportional to the diameter of hose (d) to the fifth power³⁸. There are however, considerable logistical and physiological issues associated with firefighting with this larger hose due to its weight and lack of flexibility questioning its use as a viable hose choice for search and rescue operations.
- 8.6 The data obtained from the simulated fire attack from a rising main were obtained with the supplying pump and branch on the same elevation. If a fire attack were to be mounted from the floor beneath the fire floor, there would be additional losses due to the static head arising from the difference in floor heights, plus frictional loss from any additional hose required to reach the fire. In these circumstances these losses would have to be taken into account in deciding whether a branch would be able to attain the minimum criteria outlined in this report.
- 8.7 Whilst this assessment considered the performance of firefighting branches from a wet rising main similar issues will arise with a dry rising main. This is due to the frictional losses associated with the choice of hose and the increasing hydraulic losses due to static head as the elevation in the building increases.
- 8.8 Branches 51, 54, 59 and 70 were of the 'automatic' type (the branch reacts to the volume of water supplied and adjusts itself to deliver this volume as effectively as possible at constant pressure). These branches are designed to operate upwards of a stated minimum operating pressure of 6 or 7 bars. As the outlets of wet rising mains are pressure regulated to 4 to 5 bars these branches as well as those with operating pressures similar to the pressure regulation on the riser outlet may not be appropriate to use in high-rise firefighting with existing operating procedures.

- 8.9 At 4 bar pump pressure when using the 45mm diameter hose only branch number 53 attained a pressure equal or greater than the pass pressure defined by the professional panel. When the pump pressure was increased to 5 bar, branches numbers 46, 47, 48, 53, 57, 58 and 68 attained the corresponding pass pressure.
- 8.10 When using 51mm diameter hose at 4 bar pump pressure branches numbers 48, 53, 57, 58 and 68 attained a pressure equal or greater than the pass pressure defined by the professional panel. When the pump pressure was increased to 5 bar branches numbers 45, 46, 47, 48, 49, 53, 55, 57, 58, 67 and 68 attained the corresponding pass pressure.
- 8.11 At 4 bar pump pressure and using the 70mm diameter hose all branches attained a pressure equal or greater than the pass pressure defined by the professional panel except numbers 50, 51, 54, 56, 59, 64, 65 and 69.
- 8.12 At 5 bar pump pressure and using the 70mm diameter hose all branches attained the corresponding pass pressure except numbers 51, 54 and 59. It should be borne in mind that these branches are not designed to operate below 6 or 7 bar.
- 8.13 The pressure available at the riser outlet in a dry rising main is largely determined by the performance of the fire appliance pump supplying the main. In the UK there is no standard pressure for charging a rising main. Whilst fire appliance and hose lines have nominal and maximum working pressures of 10³⁹ and 15⁴⁰ bar respectively, charging pressures used typically range from 7 to 10 bars. As the change over to a wet rising main is at 60m the pressure available for firefighting at higher elevations will vary significantly due to static head loss. Pressure loss through static head at 60m equates to approximately 6 bars (Equation 1 beneath⁴¹).

$$P \text{ loss bars} = \frac{\text{Height in metres}}{10}, \frac{60}{10} = 6 \text{ bar loss}$$

Equation 1: Estimate of static loss at 60m elevation

- 8.14 Therefore before allowing for other losses, an input pressure of 10 bars would leave, in the worst case, 4 bars pressure at the riser outlet. This pressure equates to the lower pressure requirement for wet rising mains, the results of which have been presented above. Whilst 7 bars input pressure would leave 1 bar at the riser outlet which would be inadequate for any form of firefighting attack.
- 8.15 At lower elevations in a building the hydraulic losses will be less. **For some of the branches evaluated there will be an elevation where the pressure available at the dry riser outlet is not sufficient to support adequate compartment firefighting tactics with either 45mm or 70mm hose.** For the same firefighting branch, where 45mm hose is used, this elevation will be significantly less than that where 70mm hose is used. The limits for compartment firefighting with 51mm hose will lie between the two other hose sizes. As discussed in 6.13 and 6.14 this hose however offers the benefits of improved manual handling over 70mm hose and increased hydraulic performance over 45mm hose.

- 8.16 The above factors will result in a range of performance envelopes where for a specific branch, dependent upon the size, length of hose line and the flowrate the pressure available at the rising main outlet may not be sufficient to support compartment firefighting tactics. This has implications for the procedures and choice of equipment used to fight a fire in a tall building.
- 8.17 To achieve the riser flowrate of 500 litres/min, when using 69m of 45mm hose, required in excess of the current pressure regulated limits for a wet riser (4 to 5 bars). For the branches under evaluation a minimum of 6.7 bars was required before any of the branches under evaluation attained the flowrate. Ten branches were unable to attain the flowrate within the test limit of 9 bars maximum.
- 8.18 When using 69m of 51mm hose at 5 bars pressure only 3 branches achieved the riser flowrate of 500 litres/min, whilst 6 branches did not attain this flowrate even at the test limit of 9 bars pressure.
- 8.19 When using 69m of 70mm hose at 4 bars running pressure, 6 branches were able to attain the flowrate. At 5 bars, a further 4 branches attained the flowrate and subjective criteria. As with the 45mm and 51mm hose assessment a number of branches required up to 9 bars to achieve the flowrate, with 2 branches not attaining the flowrate within the test limit of 9 bar maximum.
- 8.20 The assessments recorded in 8.17, 8.18 and 8.19 indicate that there is limited correlation between the running pressure and flowrates specified for wet rising mains with the branches assessed indicating that the performance criteria specified is not empirically based and should be reviewed.

9.0 Conclusions

- 9.1 The subjective performance of firefighting branches decreases with decreasing pressures.
- 9.2 There is significant variation in the pressure above which the subjective performance of firefighting branches is considered adequate to undertake the techniques taught for compartment firefighting. An operating pressure of 4 bars at the branch would be needed for the majority of the branches assessed.
- 9.3 The pressure drop across 69m of 45mm hose is so significantly large, that at low pressures, the majority of the branches assessed were not able to achieve the performance requirement to adequately undertake techniques that are taught for compartment firefighting.
- 9.4 When firefighting in tall buildings fitted with dry rising mains, with some firefighting branches there will be an elevation beyond which there is inadequate pressure to undertake compartment firefighting techniques. This elevation will depend upon the charging pressure used for the rising main, size and length of hose used for the attack line, the flow and the specific performance of the firefighting branch used. Account also needs to be taken of kinking in the hose line at low pressures and the effect this has upon the pressure and flow available at the firefighting branch. For the same firefighting branch, where 45mm hose is used, this elevation will be significantly less than that where 70mm hose is used. If 51mm hose was used a firefighting attack could be mounted at higher elevations than could be achieved with 45mm hose currently used by most fire and rescue services.
- 9.5 When firefighting in tall buildings fitted with wet rising mains, the pressure at the riser outlet is regulated between 4 and 5 bars. Dependant upon the size of the hose and the specific performance of the firefighting branch there may be insufficient pressure available at the firefighting branch to undertake techniques that are taught for compartment firefighting. Again this situation will be exacerbated where smaller diameter hose is used for the attack line.
- 9.6 There appears to be limited correlation between the running pressure and flowrates specified for wet rising mains indicating that the performance criteria specified is not empirically based and should be reviewed.
- 9.7 The equipment specified in the high-rise generic risk assessment produced by HM Fire Service Inspectorate does not align to building design configurations allowable under the building regulations, or for the use of safety teams covering the main fire attack team. This assessment requires reviewing in light of the results of this work and future work examining the performance limitations of firefighting from a dry rising main.

9.8 Whilst this report considers firefighting from a rising main, should that system fail through, for example poor maintenance, or in extreme circumstances the effects of terrorism, there would be a range of different performance envelopes where:

- the techniques for compartment firefighting cannot be undertaken and,
- direct firefighting attack cannot be mounted without undertaking a vertical water relay.

Summary

9.9 Tall buildings pose unique firefighting challenges as firefighting and search and rescue operations can only be undertaken within the building, often at considerable heights above the fire service access level. The facilities installed in these buildings will have a direct bearing on the tactics to be adopted, with firefighting shafts with firefighting lifts, rising mains and smoke control facilities being provided to assist firefighters. The events of September 11th and several other incidents have shown that there are limitations on the size of fire that can be dealt with in a tall building and the possibility that building systems designed to assist firefighting may fail. Changes have also occurred in firefighting tactics, which have resulted in the performance standards for building systems provided to assist firefighting not aligning to the firefighting tactics adopted in tall buildings.

9.10 Overarching all these issues is the consideration that there is no national policy for high-rise firefighting and search and rescue operations that accounts for:

- The type and limitation of facilities provided to assist the fire and rescue service in dealing with fires in tall buildings.
- Minimum pressure requirements for firefighting branches when used in tall buildings and thus corresponding water flowrates.
- The physiological performance of firefighters both in normal circumstances and also more extreme events where fixed installations such as risers or firefighting lifts have failed.

10.0 Recommendations

- 10.1 The results highlight the fact that fire and rescue services may need to evaluate the performance of the branch types that they use during high-rise firefighting operations to comply with their obligations under Section 4 of The Provision and Use of Work Equipment Regulations []. This will include other influencing factors such as the pressures available from dry/wet riser systems and the diameter and lengths of hose used.
- 10.2 New performance standards for rising mains within tall buildings should be developed at the earliest opportunity that are compatible with effective compartment firefighting techniques needed to support the safety of firefighters.
- 10.3 The performance envelopes identified in 8.16 should be investigated in future work, together with contingency arrangements to extend the performance envelope for firefighting in the event of failure of the facilities designed to support firefighting in tall buildings.
- 10.4 Fire and rescue services should consider the adoption of 51mm hose instead of 45mm hose for high-rise fighting. This is due to its improved hydraulic characteristics and its ability to supply an adequate firefighting attack from fixed installations which may not be achievable with 45mm hose. These benefits would also apply to other firefighting applications currently undertaken with 45mm hose.
- 10.5 The generic risk assessment for high-rise firefighting and search and rescue procedures produced by HM Fire Service Inspectorate should be revised in light of the results of this work and the output from item 10.6 beneath.
- 10.6 An agreed National high-rise firefighting and search and rescue procedure should be developed, which reflects:
 - the type, performance and limitations of firefighting facilities provided in tall buildings,
 - the physiological limitations of firefighting in tall buildings,
 - the performance and limitations of fire and rescue service equipment designed to support firefighting in tall buildings and
 - contingency arrangements for possible failure of facilities designed to support firefighting in tall buildings.

APPENDIX A

Details of Branches

Table A1: Details of branches tested

Branch Number	Manufacturer	Model	Setting
26	Akron Brass Co. (USA)	Marauder Style 4516	125 gpm (US)
45	Rosenbauer	RB 102	750 lpm
46	Rosenbauer	Autoflow RB 201	
47	Deltafire	Mainline Nozzle DM600	
48	Akron Brass Co. (USA)	Turbojet 1763	750 lpm
49	Akron Brass Co. (USA)	Assault 4820 (550lpm)	
50	Leader Group	Quadrafog – 500T	475 lpm
51	Leader Group	TFT Midmatic	
52	Leader Group	TFT Duojet PP	Red Stem
53	Elkhart Brass Manufacturing Co. INC. (USA)	Chief 4000-13	
54	Elkhart Brass Manufacturing Co. INC. (USA)	Selectomatic SM 20-FG	
55	Elkhart Brass Manufacturing Co. INC. (USA)	Model 205 – Industrial	
56	Williams Fire & Hazard Control	Viper – Select – Hydrojet – SG 9520	125 gpm (US)
57	William Eagles	Buccaneer – Type A – 450S	
58	William Eagles	Buccaneer – Type B – TK500	500 lpm
59	William Eagles	Buccaneer – Type C – TM500	
60	Hughes Engineering Ltd.	Noble BP1	
61	Hughes Engineering Ltd.	Noble BP1 – FR	
62	Hughes Engineering Ltd.	Noble Powerjet – NPJ7	0.5"nozzle
63	AWG	M2540	16mm nozzle
64	Unifire	V12	12mm
65	Unifire	V16	16mm
66	Unifire	V20	20mm
67	Angus Fire Armour Ltd.	Diffuser "Cooperspray"	
68	Angus Fire Armour Ltd.	Hi-Combat style 367B	750 lpm
69	Galena Fire Engineering Ltd.	Hyperfog 700	
70	TA Incentive Group	Fogfighter	

APPENDIX B

Results of Branch Performance Trials

Table B1: Results of branch performance evaluation against subjective criteria outlined in Section 4.3

Branch Number	Manufacturer	Model	Setting	Pass Pressure (Bar)	Full Cone			Half Cone			70° Cone			Jet			
					Flow (lpm)	Breadth (m)	Range to Breadth (m)	Cone Angle (Degrees)	Flow (lpm)	Breadth (m)	Range to Breadth (m)	Flow (lpm)	Breadth (m)	Range to Breadth (m)	Flow (lpm)	Throw (m)	Breadth (m)
45A	Rosenbauer	RB 102	360	2	235	7.2	3.0	120	235	3.9	3.8	235	4.7	4.0	235	8.1	0.3
45B	Rosenbauer	RB 102	475	2	264	7.4	3.4	120	264	3.5	4.4	264	4.4	4.1	264	8.3	0.3
45C	Rosenbauer	RB 102	550	2	353	7.6	3.2	120	353	4.1	3.9	353	4.8	3.9	353	8.3	0.3
45D	Rosenbauer	RB 102	750	2	457	8.0	3.9	120	457	3.8	4.5	457	4.5	3.9	457	8.3	0.3
46	Rosenbauer	Autoflow RB 201		4	150	8.0	2.8	120	150	3.9	4.2	150	4.6	3.9	150	10.8	0.3
47A	Deltafire	Mainline Nozzle DM600	Handle Position 2														
47B	Deltafire	Mainline Nozzle DM600	Handle Position 3														
47C	Deltafire	Mainline Nozzle DM600	Handle Position 4														
47D	Deltafire	Mainline Nozzle DM600	Handle Position 5	3	232	8.9	2.8	114	243	4.4	5.3	298	5.3	4.9	237	8.5	0.2
47E	Deltafire	Mainline Nozzle DM600	Handle Position 6	3	310	9.0	3.9	114	309	4.5	5.7	324	5.2	5.2	303	9.0	0.3
48A	Akron Brass Co. (USA)	Turbojet 1763	115														
48B	Akron Brass Co. (USA)	Turbojet 1763	360	2	202	10.0	3.5	120	202	5.2	4.8	202	5.8	4.9	202	8.0	0.3
48C	Akron Brass Co. (USA)	Turbojet 1763	475	2	273	11.2	4.0	120	273	5.0	5.0	273	5.5	4.8	273	8.8	0.3
48D	Akron Brass Co. (USA)	Turbojet 1763	550	2	323	11.3	4.3	120	323	4.2	5.0	323	5.8	4.8	323	8.7	0.3
48E	Akron Brass Co. (USA)	Turbojet 1763	750	2	432	11.2	4.1	120	432	3.5	4.5	432	4.5	4.7	432	8.3	0.3
49	Akron Brass Co. (USA)	Assault 4820		3	413	8.2	4.1	110	397	3.0	4.7	383	4.8	4.8	388	9.8	0.3
50A	Leader Group	Quadrafog - 500T	100														
50B	Leader Group	Quadrafog - 500T	250	4	197	9.3	3.2	130	197	3.7	4.1	197	4.1	4.0	197	11.8	0.3
50C	Leader Group	Quadrafog - 500T	350	4	281	9.4	3.3	130	281	4.1	3.9	281	4.6	3.9	281	12.0	0.3

NB. Greyed out areas indicate a setting where the branch did not meet the minimum criteria of the professional panel.

Table B1: Results of branch performance evaluation against subjective criteria outlined in Section 4.3 (continued)

Branch Number	Manufacturer	Model	Setting	Pass Pressure (Bar)	Full Cone			Half Cone			70° Cone			Jet			
					Flow (lpm)	Breadth (m)	Range to Breadth (m)	Cone Angle (Degrees)	Flow (lpm)	Breadth (m)	Range to Breadth (m)	Flow (lpm)	Breadth (m)	Range to Breadth (m)	Flow (lpm)	Throw (m)	Breadth (m)
50D	Leader Group	Quadrafog – 500T	475	4	396	10.0	3.7	130	396	3.3	4.1	396	4.3	4.2	396	12.1	0.3
51	Leader Group	TFT Midmatic	7	558	5.9	3.4	100	613	3.8	5.0	547	5.0	4.7	463	14.0	0.3	
52A	Leader Group	TFT Duojet PP	Blue Stem, Handle Position 2														
52B	Leader Group	TFT Duojet PP	Blue Stem, Handle Position 3														
52C	Leader Group	TFT Duojet PP	Blue Stem, Handle Position 4														
52D	Leader Group	TFT Duojet PP	Blue Stem, Handle Position 5														
52E	Leader Group	TFT Duojet PP	Blue Stem, Handle Position 6														
52F	Leader Group	TFT Duojet PP	Blue Stem, Handle Position 7														
52G	Leader Group	TFT Duojet PP	Red Stem, Handle Position 2														
52H	Leader Group	TFT Duojet PP	Red Stem, Handle Position 3														
52I	Leader Group	TFT Duojet PP	Red Stem, Handle Position 4														
52J	Leader Group	TFT Duojet PP	Red Stem, Handle Position 5	3	329	8.2	4.0	105	338	4.0	6.0	318	7.3	5.4	320	8.0	0.3
52K	Leader Group	TFT Duojet PP	Red Stem, Handle Position 6	3	414	8.2	4.1	105	397	4.1	5.4	368	5.8	5.0	384	8.6	0.3
52L	Leader Group	TFT Duojet PP	Red Stem, Handle Position 7	3	462	7.7	4.2	105	443	3.6	6.4	405	6.8	5.0	474	9.0	0.3
53	Elkhart Brass Manufacturing Co. INC. (USA)	Chief 4000-3		2	322	8.3	4.1	124	322	4.7	5.0	322	5.2	4.9	322	8.2	0.3
54	Elkhart Brass Manufacturing Co. INC. (USA)	Selectomatic SM 20-FG		7	702	6.4	3.5	112	716	2.4	4.8	735	3	5	764	14.0	0.3
55	Elkhart Brass Manufacturing Co. INC. (USA)	Model 205 – Industrial		3	448	12.8	4.0	134	490	3.3	6.1	490	4.5	4	207	9.1	0.3
56A	Williams Fire & Hazard Control	Viper – Select – Hydrojet – SG 9520 30															
56B	Williams Fire & Hazard Control	Viper – Select – Hydrojet – SG 9520 60		4	185	8.8	3.5	116	185	4.0	4.0	185	4.4	3.9	194	10.5	0.3
56C	Williams Fire & Hazard Control	Viper – Select – Hydrojet – SG 9520 95		4	275	9.8	3.5	116	275	3.9	4.3	275	4.3	4.0	275	10.4	0.3
56D	Williams Fire & Hazard Control	Viper – Select – Hydrojet – SG 9520 125		4	370	7.5	3.5	116	370	3.4	4.5	370	3.8	5.1	370	9.9	0.3
57	William Eagles	Buccaneer – Type A – 450S		3	276	7.4	4.0	106	281	3.4	4.9	276	5.1	4.6	269	9.1	0.3
58A	William Eagles	Buccaneer – Type B – TK500	150														
58B	William Eagles	Buccaneer – Type B – TK500	300														

NB. Greyed out areas indicate a setting where the branch did not meet the minimum criteria of the professional panel

Table B1: Results of branch performance evaluation against subjective criteria outlined in Section 4.3 (continued)

Branch Number	Manufacturer	Model	Setting	Pass Pressure (Bar)	Full Cone			Half Cone			70° Cone			Jet			
					Flow (lpm)	Breadth (m)	Range to Breadth (m)	Cone Angle (Degrees)	Flow (lpm)	Breadth (m)	Range to Breadth (m)	Flow (lpm)	Breadth (m)	Range to Breadth (m)	Flow (lpm)	Throw (m)	Breadth (m)
58C	William Eagles	Buccaneer – Type B – TK500	500	3	323	6.3	4.0	90	315	2.9	3.5	315	5.2	5.0	317	9.4	0.3
59	William Eagles	Buccaneer – Type C – TM500		6	175	4.2	2.7	90	175	2.8	3.8	175	2.8	2.9	175	13.0	0.3
64	Unifire	V12	12mm	4	418	6.0	3.0	120	267	4.2	4.2	275	5.8	5.0	158	12.3	0.3
65	Unifire	V16	16mm	4	481	6.7	3.0	120	335	4.8	4.5	355	5.8	4.9	218	12.0	0.3
66	Unifire	V20	20mm	3	477	7.2	3.6	112	352	2.3	4.4	330	3.7	4.0	294	10.1	0.3
67	Angus Fire Armour Ltd.	Diffuser "Cooperspray"		3	427	7.1	4.8	96	375	3.0	4.9	396	4.8	5.0	254	10.6	0.3
68A	Angus Fire Armour Ltd.	Hi-Combat style 367B	360														
68B	Angus Fire Armour Ltd.	Hi-Combat style 367B	475	2	264	7.1	3.5	116	264	3.8	4.2	264	4.6	4.5	264	7.8	0.3
68C	Angus Fire Armour Ltd.	Hi-Combat style 367B	550	2	321	7.7	3.5	116	321	3.9	4.5	321	5.0	4.6	321	8.1	0.3
68D	Angus Fire Armour Ltd.	Hi-Combat style 367B	750	2	407	8.2	4.0	116	407	3.7	4.8	407	4.3	4.4	407	7.9	0.3
69	Galena Fire Engineering Ltd.	Hyperfog 700		4	560	8.0	4.3	120	510	4.4	5.8	515	4.3	4.0	438	11.0	0.3
70	TA Incentive Group	Fogfighter		7	410	6.0	3	110	355	2.4	4.3	371	3	3.5	330	16.3	0.4

NB. Greyed out areas indicate a setting where the branch did not meet the minimum criteria of the professional panel.

Table B2: Results of combining branch performance with firefighting attack from a rising main using 69m of 45m hose

Collar Branch Setting	4 Bar Pump Pressure				5 Bar Pump Pressure				500 lpm or Maximum Pump Pressure of 9 Bar				
	Flow	Branch Pressure	Branch Pass Pressure	PASS	Flow	Branch Pressure	Branch Pass Pressure	PASS	Pump Pressure	Flow	Branch Pressure	Branch Pass Pressure	Flow Achieved
45 750	380	1.5	2	N	427	1.7	2	N	6.7	498	2.4	2	Y
46	142	3.5	4	N	161	4.5	4	Y	9.0	310	7.5	4	N
47	266	2.7	3	N	325	3.0	3	Y	9.0	496	4.9	3	Y
48 750	361	1.5	2	N	407	2.0	2	Y	7.2	498	2.9	2	Y
49	318	2.0	3	N	361	2.4	3	N	9.0	501	4.5	3	Y
50 475	305	2.4	4	N	337	3.0	4	N	9.0	466	5.5	4	N
51	81	3.9	7	N	113	4.8	7	N	9.0	377	6.6	7	N
52 Red Stem	326	2.1	3	N	360	2.6	3	N	7.5	500	3.3	3	Y
53	322	2.0	2	Y	363	2.5	2	Y	8.8	503	4.8	2	Y
54	195	3.2	7	N	222	4.0	7	N	9.0	433	6.0	7	N
55	350	1.9	3	N	388	2.4	3	N	8.0	501	3.8	3	Y
56 125	297	2.4	4	N	333	3.0	4	N	9.0	430	6.0	4	N
57	264	2.8	3	N	294	3.4	3	Y	9.0	403	6.4	3	N
58 500	294	2.5	3	N	322	3.1	3	Y	9.0	443	5.8	3	N
59	80	3.9	6	N	90	4.8	6	N	9.0	350	7.0	6	N
60	Not Tested												
61	Not Tested												
62	Not Tested												
63	Not Tested												
64	310	2.3	4	N	352	2.8	4	N	9.0	490	5.1	4	N
65	326	2.0	4	N	373	2.5	4	N	8.5	500	4.2	4	Y
66	349	1.7	3	N	394	2.1	3	N	7.5	500	3.4	3	Y
67	326	2.1	3	N	360	2.7	3	N	9.0	484	5.4	3	N
68 750	364	1.5	2	N	416	2.0	2	Y	7.0	498	2.7	2	Y
69	350	1.6	4	N	406	2.0	4	N	7.5	501	3.2	4	Y

NB All pressures are in Bar. All flowrates are in litres/minute

Table B3: Results of combining branch performance with firefighting attack from a rising main using 69m of 51m hose

Collar Branch Setting	4 Bar Pump Pressure				5 Bar Pump Pressure				500 lpm or Maximum Pump Pressure of 9 Bar					
	Flow	Branch Pressure	Branch Pass Pressure	PASS	Flow	Branch Pressure	Branch Pass Pressure	PASS	Pump Pressure	Flow	Branch Pressure	Branch Pass Pressure	Flow Achieved	
45	750	449	1.8	2	N	502	2.3	2	Y	5.0	502	2.3	2	Y
46		145	3.9	4	N	167	4.8	4	Y	9.0	350	8.0	4	N
47		293	2.9	3	N	370	3.5	3	Y	7.0	493	4.8	3	Y
48	750	430	2.1	2	Y	492	2.7	2	Y	5.0	492	2.7	2	Y
49		340	2.9	3	N	376	3.6	3	Y	8.0	490	6.0	3	Y
50	475	333	2.8	4	N	374	3.6	4	N	8.5	500	6.2	4	Y
51		83	3.8	7	N	114	4.8	7	N	9.0	454	7.0	7	N
52	Red Stem	430	2.2	3	N	483	2.7	3	N	5.5	510	5.0	3	Y
53		375	2.6	2	Y	415	3.2	2	Y	7.0	495	4.5	2	Y
54		209	3.5	7	N	235	4.4	7	N	8.5	496	6.2	7	N
55		406	2.4	3	N	455	3.0	3	Y	6.0	499	3.7	3	Y
56	125	322	3.0	4	N	346	3.8	4	N	9.0	468	7.0	4	N
57		283	3.1	3	Y	317	3.9	3	Y	9.0	431	7.2	3	N
58	500	312	3.0	3	Y	355	3.8	3	Y	9.0	483	7.0	3	N
59		80	4.0	6	N	92	5.0	6	N	9.0	419	7.5	6	N
60	Not Tested													
61	Not Tested													
62	Not Tested													
63	Not Tested													
64		358	2.7	4	N	397	3.4	4	N	7.5	504	5.2	4	Y
65		386	2.5	4	N	429	3.0	4	N	6.5	505	4.1	4	Y
66		419	2.3	3	N	464	2.9	3	N	6.0	516	3.5	3	Y
67		362	2.6	3	N	401	3.4	3	Y	7.5	492	5.4	3	Y
68	750	433	2.2	2	Y	496	2.7	2	Y	5.0	496	2.7	2	Y
69		433	2.2	4	N	474	2.8	4	N	5.5	503	3.2	4	Y

NB. All pressures are in Bar. All flowrates are in litres/minute

Table B4: Results of combining branch performance with firefighting attack from a rising main using 69m of 70m hose

Collar Branch Setting	4 Bar Pump Pressure				5 Bar Pump Pressure				500 lpm or Maximum Pump Pressure of 9 Bar					
	Flow	Branch Pressure	Branch Pass Pressure	PASS	Flow	Branch Pressure	Branch Pass Pressure	PASS	Pump Pressure	Flow	Branch Pressure	Branch Pass Pressure	Flow Achieved	
45	750	588	3.1	2	Y	680	4.0	2	Y	4.0	588	3.1	2	Y
46		148	4.0	4	Y	169	5.0	4	Y	9.0	400	8.8	4	N
47		415	3.6	3	Y	477	4.5	3	Y	5.5	501	5.0	3	Y
48	750	540	3.5	2	Y	610	4.2	2	Y	4.0	540	3.5	2	Y
49		452	3.5	3	Y	502	4.5	3	Y	5.0	502	3.5	3	Y
50	475	375	3.6	4	N	421	4.5	4	Y	6.5	495	6.0	4	Y
51		83	4.0	7	N	152	4.9	7	N	7.5	500	7.0	7	Y
52	Red Stem	530	3.5	3	Y	690	4.0	3	Y	4.0	530	3.5	3	Y
53		440	3.5	2	Y	495	4.5	2	Y	5.0	495	3.5	2	Y
54		222	3.9	7	N	248	4.8	7	N	6.8	503	6.3	7	Y
55		486	3.5	3	Y	548	4.4	3	Y	5.0	548	3.5	3	Y
56	125	344	3.6	4	N	388	4.7	4	Y	8.4	495	7.8	4	Y
57		307	3.7	3	Y	352	4.7	3	Y	9.0	476	8.5	3	N
58	500	352	3.7	3	Y	398	4.6	3	Y	7.7	494	7.3	3	Y
59		81	4.4	6	N	92	5.0	6	N	8.5	500	8.0	6	Y
60	Not Tested													
61	Not Tested													
62	Not Tested													
63	Not Tested													
64		408	3.6	4	N	463	4.5	4	Y	5.9	501	5.4	4	Y
65		464	3.6	4	N	524	4.5	4	Y	5.0	524	3.6	4	Y
66		503	3.5	3	Y	572	4.4	3	Y	4.0	503	3.5	3	Y
67		411	3.6	3	Y	455	4.5	3	Y	6.1	497	5.5	3	Y
68	750	552	3.4	2	Y	620	4.2	2	Y	4.0	552	3.4	2	Y
69		514	3.5	4	N	583	4.3	4	Y	4.0	514	3.5	4	Y

NB. All pressures are in Bar. All flowrates are in litres/minute

APPENDIX C

Historical background and current provision of rising mains in tall buildings

Post-War Building Studies

The current guidance on the provision of rising mains to support firefighting mainly stems from Post War Building studies undertaken by the Joint Committee of the Building Research Board of the Department of Scientific & Industrial Research and of the Fire Officers' Committee. This was one of a series of committees to *"investigate and report on the major problems which were likely to affect peacetime building"*⁴³.

The scope of the studies were to set out the underlying principles of fire grading through *"Investigation and assigning of suitable fire precautions of any kind to attain an adequate standard of safety, according to the fire hazard of the building under consideration"*.⁴⁴

Guidance on the provision of rising mains was made as means to speed extinguishing operations. There were three main premises underlying the rationale of measures to speed extinguishing operations.

Firstly, recognition that *"the less the degree of fire resistance of the structure in relation to its fire load the less would be the time available to prevent a serious fire from spreading from the compartment in which it started to other parts of the building."*⁴⁵

Secondly, as the height of the building increased, so did the difficulty in tackling the fire, in particular when buildings exceeded the reach of the turntable ladder at 100ft.

Thirdly, as floor areas increased, again the difficulty in tackling the fire increased and the potential size of fire also increased.

To overcome the delays associated with running hose out to the fire scene, recommendations were made for the provision of internal mains with hydrants and rising mains.

*"It follows that all reasonable precautions should be taken to enable the fire service to expedite the extinguishing operations. In this connection the incorporation of mains fitted with hydrants in the building reduces the necessity for laying out lines of hose up staircases or over long distances a cumbersome and slow process and thus permits water to be applied more quickly to the seat of fire."*⁴⁶

Internal mains with hydrants were recommended in three circumstances (paraphrase)⁴⁷.

1. *Within buildings or divisions exceeding 10,000 sq ft and where any part of the floor was more than 100ft from the street..,*
2. *In the case of buildings exceeding 100ft in height.*
3. *Abnormal occupancies where time delays in attacking the fire would be more crucial than normal occupancies.*

It is appropriate to note that the provision of rising mains followed a functional requirement of one outlet per 10,000 sq. ft (929m²), provided all parts were within reach of a $\frac{3}{4}$ " jet from not more than 100 ft of hose, including parts which are enclosed by partitions"⁴⁸. This functional requirement forms the basis for the current criterion of one outlet per 900m² ⁴⁹, although as detailed later the criterion for all parts of the floor area to be within reach of a jet from not more than 100 ft of hose (30m) is presently set at 60m.

There was also a relationship between the expected attendance time for appliances attending a property and whether the main needed to be wet or was permissible to be a dry rising main to be charged by firefighters upon their arrival. Where there was a reasonable certainty of two appliances attending within 5 minutes it was permissible for the main to be dry in buildings less than 100ft high.⁵⁰

CP3 Code of Basic Data for the Design of Buildings. Precautions against Fire.

In the 1960s to reflect that the fire service had a maximum rescue capability using ladders (wheeled escapes) of 60 feet, risers were required in buildings above this height to speed extinguishing operations. This requirement was provided through CP3 Publications: Part 1 for Flats and Maisonettes⁵¹, Part 2 for Shops and Departmental Stores⁵² and Part 3 for Office Buildings⁵³. These standards also set the present criterion that in buildings over 200 feet the risers should be permanently charged and described as wet risers. The implicit rationale for this height drew from the maximum elevation that a fire appliance supplying a rising main could supply a jet of water using $2\frac{3}{4}$ " hose (70mm) when connected to the riser outlet. The two trigger heights of 60 and 200 feet are reflected as 18m and 60m in current requirements.

Other current requirements

Approved Document B, Fire Safety. 2000

The guidance provided through Approved Document B to the Building Regulations is covered in Section 2.0 of the main report.

Scottish Technical Standards

In Scotland the Building Standards (Scotland) Regulations 1990, as amended apply. Compliance with these Regulations is achieved through The Technical Standards⁵⁴. Facilities for firefighting are contained within Part E and are supported by provisions that are deemed to satisfy the standards. The standards contain the same criterion as Approved Document B for when a riser should change from a dry to a wet standard and a similar controlling criterion for restricting the distance of the floor from the riser outlet:⁵⁵

“escape stairs must be provided with firefighting facilities in accordance with the table to this standard and located so that they are,

- a. at least 20 m apart; and*
 - b. so that no point on any storey is further from a firefighting outlet than 1 storey height, and*
- ii. 60 m measured along an unobstructed route for fire hose.”*

The provisions deemed to satisfy the Technical Standards in respect of fire mains state⁵⁶ that the requirements will be met where:

- a. the wet fire main is in accordance with BS 5306: Part 1: 1976 (1988); and*
- b. the landing valves conform to BS 5041: Part 1: 1987.*

For dry mains the requirements will be met where:

The main is in accordance with BS 5306: Part 1: 1976 (1988); and where there are:

- a. landing valves for dry fire mains, they conform to BS 5041: Part 2: 1987; and*
- b. inlet breechings for dry fire mains, they conform to BS 5041: Part 3: 1975 (1987); and....”*

British Standards

PD7974-5 (Sub-system 5), Application of Fire Safety Engineering Principles to the Design of Buildings – Part 5: Fire Service Intervention

PD 7974-5 provides a framework for developing a rational methodology for design using a fire safety engineering approach through the application of scientific and engineering principles to the protection of people, property and the environment from fire. When considering fire service intervention the standard recommends that rising mains be provided in buildings over 11m adjacent to any escape stair. In buildings with a storey height of 18 m or more the main is within a firefighting shaft⁵⁷. For the standard of the firefighting shaft PD 7974-5 references BS 5588-5, *Fire precautions in the design, construction and use of buildings – Code of practice for firefighting stairs and lifts* which is discussed later.

BS 5588: Part 5 Code of practice for firefighting stairs and lifts

Guidance for designers in providing firefighting stairs and lifts to assist the fire service in firefighting operations is contained in BS 5588: Part 5 Code of practice for firefighting stairs and lifts⁵⁸. The standard also contains the controlling criterion that the distance from the riser outlet to any point on the storey does not exceed 60m⁵⁹.

In respect of the technical standards for the risers this states⁶⁰ that wet and dry rising mains (and falling) mains should be installed in accordance with BS5306: Part 1.

Whilst the code does not include a recommendation for the provision of fire mains in buildings provided with firefighting stairs but no lift, it advocates that this should not preclude the provision of fire mains in such buildings⁶¹.

BS 5306: Part 1:1976 Fire Extinguishing installations and equipment on premises⁶².

Inter alia BS 5306 specifies that rising mains should be provided where buildings are over 18m in height and where the building exceeds 60m wet rising mains should be provided⁶³. The number of rising mains is also determined by criteria of one rising main for every 900m², or any part thereof, of the floor area at each level other than the ground floor. Also no part of a floor area should be more than 60m distant from a landing valve: the distance to be measured along a suitable route for laying hose lines, including the distance up and down a stairway⁶⁴.

Where wet risers are provided, the standard specifies that each pump should be capable of providing a flow of water of at least 25 litres/s (1500 litres/min) in the wet rising main, i.e. sufficient to supply three lines of hose from three landing valves simultaneously. A minimum running pressure of 4 bar and a maximum of 5 bar should be maintained at each landing valve when any number, up to three, are fully opened⁶⁵. The pressure regulation criteria for wet rising mains was used to support practical trials outlined earlier in the report.

BS 5588 Fire Precautions in the design, construction and use of buildings

This standard contains a number of Parts offering guidance on fire service access and facilities, which call up similar requirements on the provision and standards of rising mains, namely:

- BS 5588: PART 1: DWELLINGS⁶⁶,
- BS 5588: PART 6: PLACES OF ASSEMBLY⁶⁷,
- BS 5588: PART 10: SHOPPING COMPLEXES⁶⁸,
- BS 5588: PART 11: SHOPS, OFFICES, INDUSTRIAL, STORAGE & OTHER SIMILAR BUILDINGS⁶⁹.

BS 9999 – Clause 8: 2001 Access and facilities for firefighting

BS 9999 is intended to replace a number of Parts of the BS5588 series. The draft under development also contains recommendation in clause 8 for the provision and standards for rising mains⁷⁰. The provisions and standards for rising mains follow those detailed in PD 7974-5 (Sub-system 5) which was reviewed above.

References

- 1 Department of the Environment Transport and Regions The Building Regulations 1991. Approved Document B. Fire Safety HMSO London 2000 Page 100
- 2 Department of the Environment Transport and Regions The Building Regulations 1991. Approved Document B. Fire Safety HMSO London 2000 Page 100
- 3 Department of the Environment Transport and Regions The Building Regulations 1991. Approved Document B. Fire Safety HMSO London 2000, Section 18.
- 4 Department of the Environment Transport and Regions The Building Regulations 1991. Approved Document B. Fire Safety HMSO London 2000 Page 106
- 5 Department of the Environment Transport and Regions The Building Regulations 1991. Approved Document B. Fire Safety HMSO London 2000 Page 100
- 6 British Standards Institution. BS5306: Part1:1976. Fire Extinguishing installations and equipment on premises. Part 1. Hydrant systems, hose reels and foam inlets (formerly CP 402.101). London, BSI, 1976.
- 7 British Standards Institution. BS5306: Part1:1976. Fire Extinguishing installations and equipment on premises. Part 1. Hydrant systems, hose reels and foam inlets (formerly CP 402.101). London, BSI, 1976.
- 8 British Standards Institution. BS5306: Part1:1976. Fire Extinguishing installations and equipment on premises. Part 1. Hydrant systems, hose reels and foam inlets (formerly CP 402.101). London, BSI, 1976, section 9.4.4
- 9 British Standards Institution. BS 6391 Non- percolating layflat delivery hoses and hose assemblies for firefighting purposes: 1983, London, BSI, 1983, section 5 page 1.
- 10 A Guide to Operational Risk Assessment, Fire Service Guide, Volume 3, HM Fire Service Inspectorate Publications Section, The Stationery Office, 1998, Section 3.2.
- 11 HSE Improvement Notice to South Wales Fire Authority, 29 July 1996.
- 12 Fire Service Manual Volume 2: Fire Service operations – compartment fires and tactical ventilation, HMSO 11/97, 1997.
- 13 Fire Service Manual Volume 2: Fire Service operations – compartment fires and tactical ventilation, HMSO 11/97, 1997. Chapter 2 – Backdraughts, Section 5: Actions by Firefighters.
- 14 <http://www.fireservicecollege.ac.uk/datasheets/FBTI-DATA.htm>
- 15 <http://www.cfbt.info/>
- 16 Fire Service Manual, Volume 4 Fire Service Training, Guidance and Compliance Framework for Compartment Fire Behaviour Training, The Stationary Office, 2000.
- 17 Home Office – Dear Chief Officer Letter (DCOL) 11/1999 Practical Training for Compartment Fires.
- 18 Fire Service Manual, Volume 4 Fire Service Training, Guidance and Compliance Framework for Compartment Fire Behaviour Training, The Stationary Office, 2000, Section 7.1
- 19 Health and Safety a fire service guide – Dynamic Management Of Risk At Operational Incidents, HMSO, 1998, page 9.

- 20 The Provision and Use of Work Equipment Regulations 1998, ISBN 0 11 079599 7.
- 21 The Provision and Use of Work Equipment Regulations 1998, ISBN 0 11 079599 7, Part II, Section 4.
- 22 Scheffey, J. P., Siegmann, C. W., Toomey, T. A., "1994 Attack Team Workshop: Phase II – Full-Scale Offensive Fog Attack Tests," Naval Research Laboratory, NRL/MR/6180-97-7944, 1997.
- 23 Schnell, L. G., "Flashover Training in Sweden," Fire Engineers Journal, Nov. 1996, pp. 25-28
- 24 Alageel, Ewan and Swithenbank, "Mitigation of Compartment Jet Fires Using Water Sprays" University of Sheffield UK, 1998
- 25 Särndqvist, S. and Holmstedt, G. Water For Manual Fire Suppression, Journal of fire protection engineering, Vol.11, November 2001, p210-211.
- 26 Grimwood, P. "Cone-angles, Droplet sizes, Discharge velocities & Flow-rate for optimal 3D offensive gas-cooling applications," <http://www.firetactics.com/cone-angles.htm>,
- 27 Z. Liu, A. Kashef, G.D. Lougheed and N. Benichou 2002, Review Of Three Dimensional Water Fog Techniques For Firefighting, Institute for Research in Construction, National Research Council Canada, Research report: RR124, Ottawa, Canada 2002, iii.
- 28 Grimwood, P., "New Wave 3-D Water Fog Tactics: A Response to Direct Attack Advocates," Fire Engineering, October 2000
- 29 Scheffey, J. P., Siegmann, C. W., Toomey, T. A., "1994 Attack Team Workshop: Phase II –Full-Scale Offensive Fog Attack Tests," Naval Research Laboratory, NRL/MR/6180-97-7944, 1997
- 30 Z. Liu, A. Kashef, G.D. Lougheed and N. Benichou 2002, Review Of Three Dimensional Water Fog Techniques For Firefighting, Institute for Research in Construction, National Research Council Canada, Research report: RR124, Ottawa, Canada 2002, iv.
- 31 Z. Liu, A. Kashef, G.D. Lougheed and N. Benichou 2002, Review Of Three Dimensional Water Fog Techniques For Firefighting, Institute for Research in Construction, National Research Council Canada, Research report: RR124, Ottawa, Canada 2002, iii, iv.
- 32 Z. Liu, A. Kashef, G.D. Lougheed and N. Benichou 2002, Review Of Three Dimensional Water Fog Techniques For Firefighting, Institute for Research in Construction, National Research Council Canada, Research report: RR124, Ottawa, Canada 2002, xv.
- 33 Jet/Spray Branches, Data Sheets, Part 2, Central Fire Brigades Advisory Council for England and Wales, Scottish Central Fire Brigades Advisory Council, Office of the Deputy Prime Minister 2002.
- 34 Scheffey, J. P., Siegmann, C. W., Toomey, T. A., "1994 Attack Team Workshop: Phase II –Full-Scale Offensive Fog Attack Tests," Naval Research Laboratory, NRL/MR/6180-97-7944, 1997
- 35 Schnell, L. G., "Flashover Training in Sweden," Fire Engineers Journal, Nov. 1996, pp. 25-28

- 36 Alageel, Ewan and Swithenbank, "Mitigation of Compartment Jet Fires Using Water Sprays" University of Sheffield UK, 1998
- 37 Manual of firemanship book 2, Fire Service Equipment, Home Office Fire Department, HMSO, London, 1992.
- 38 Shean. P.A.D and Gray.A., Fire Technology calculations, The Institution of Fire Engineers, Leicester, 1980, page 61.
- 39 British Standards Institution. BS EN 1028-1 Fire-fighting pumps – Fire_fighting centrifugal pumps with primer Part1 : Classification – General and safety requirements London, BSI, 2002, 9 Classification and brief designation
- 40 British Standards Institution. British standard BS 6391:1983 Non-percolating layflat delivery hoses and hose assemblies for firefighting purposes London, BSI, 1983, Part 1 scope, page 1.
- 41 Shean. P.A.D and Gray.A., Fire Technology calculations, The Institution of Fire Engineers, Leicester, 1980, page 58.
- 42 The Provision and Use of Work Equipment Regulations 1998, ISBN 0 11 079599 7, Part II, Section 4.
- 43 Ministry of works. Part I General principles and structural precautions. Post War Building Studies No 20. London HMSO, 1946, inside cover.
- 44 Ministry of works. Part I General principles and structural precautions. Post War Building Studies No 20. London HMSO, 1946, page 6.
- 45 Ministry of works. Fire Grading of Buildings. Part II Fire Detection and firefighting in buildings, Part III Precautions relating to personal safety, Part IV Chimneys, flue pipes and hearths. Post War Building Studies No 29. London HMSO, 1952., page 20
- 46 Ministry of works. Fire Grading of Buildings. Part II Fire Detection and firefighting in buildings, Part III Precautions relating to personal safety, Part IV Chimneys, flue pipes and hearths. Post War Building Studies No 29. London HMSO, 1952., page 20
- 47 Ministry of works. Fire Grading of Buildings. Part II Fire Detection and firefighting in buildings, Part III Precautions relating to personal safety, Part IV Chimneys, flue pipes and hearths. Post War Building Studies No 29. London HMSO, 1952., page 21
- 48 Ministry of works. Fire Grading of Buildings. Part II Fire Detection and firefighting in buildings, Part III Precautions relating to personal safety, Part IV Chimneys, flue pipes and hearths. Post War Building Studies No 29. London HMSO, 1952., page 21
- 49 Department of the Environment Transport and Regions The Building Regulations 1991. Approved Document B. Fire Safety HMSO London 2000 page 106.
- 50 Ministry of works. Fire Grading of Buildings. Part II Fire Detection and firefighting in buildings, Part III Precautions relating to personal safety, Part IV Chimneys, flue pipes and hearths. Post War Building Studies No 29. London HMSO, 1952., page 21
- 51 British Standards Institution. Code of basic data for the design of buildings. Precautions against fire. Fire Precautions in flats and maisonettes over 80 ft in height. British Standard Code Of Practice. CP3: Chapter IV: Part 1:1962. London, BSI, 1962
- 52 British Standards Institution. Code of basic data for the design of buildings. Precautions against fire. Shops and Departmental stores. British Standard Code Of Practice. CP3: Chapter IV: Part 2:1968. London, BSI, 1968

- 53 British Standards Institution. Code of basic data for the design of buildings. Precautions against fire. Office buildings. British Standard Code Of Practice. CP3: Chapter IV: Part 3:1968. London, BSI, 1968
- 54 <http://www.scotland.gov.uk/development/bc/tslinks.asp>
- 55 Scottish Technical Standard Part E, E10.4, page 37E, 38E.
- 56 Scottish Technical Standard Part E, E10.4, page 46E.
- 57 British Standards Institution PD 7974-5 (Sub-system 5), Application of fire safety engineering principles to the design of buildings — Part 5: Fire service intervention, London, BSI, 2002, section 5.10.
- 58 British Standards Institution. BS 5588 Fire Precautions in the design, construction and use of buildings Part 5: 1991 Code of practice for firefighting stairs and lifts. London, BSI, 1991.
- 59 British Standards Institution. BS 5588 Fire Precautions in the design, construction and use of buildings Part 5: 1991 Code of practice for firefighting stairs and lifts. London, BSI, 1991, Section 3.6 page 9.
- 60 British Standards Institution. BS 5588 Fire Precautions in the design, construction and use of buildings Part 5: 1991 Code of practice for firefighting stairs and lifts. London, BSI, 1991, Section 7.2 page 20.
- 61 British Standards Institution. BS 5588 Fire Precautions in the design, construction and use of buildings Part 5: 1991 Code of practice for firefighting stairs and lifts. London, BSI, 1991, Section 7 page 19.
- 62 British Standards Institution. BS5306: Part1:1976.Fire Extinguishing installations and equipment on premises. Part 1. Hydrant systems, hose reels and foam inlets (formerly CP 402.101). London, BSI, 1976.
- 63 British Standards Institution. BS5306: Part1:1976.Fire Extinguishing installations and equipment on premises. Part 1. Hydrant systems, hose reels and foam inlets (formerly CP 402.101). London, BSI, 1976 section 6.1.1
- 64 British Standards Institution. BS5306: Part1:1976.Fire Extinguishing installations and equipment on premises. Part 1. Hydrant systems, hose reels and foam inlets (formerly CP 402.101). London, BSI, 1976 section 6.3.
- 65 British Standards Institution. BS5306: Part1:1976.Fire Extinguishing installations and equipment on premises. Part 1. Hydrant systems, hose reels and foam inlets (formerly CP 402.101). London, BSI, 1976, section 9.4.4
- 66 British Standards Institute Code of practice for residential buildings. BS 5588 Pt 1:1990 London. BSI. 1990, Section 34
- 67 British Standards. Institute Code of practice for places of assembly. BS 5588 Pt 6:1991 London BSI 1991, Section 29.2
- 68 British Standards Institute Code of practice for shopping complexes BS 5588 Pt 10:1991 London BSI 1991, Section 7.6
- 69 British Standards Institute Code of practice for shops, offices, industrial, storage and other similar buildings. BS 5588 Pt 11:1997 London BSI 1997, Section 40.5
- 70 British Standards Institution Draft BS 9999 Fire Safety, London, BSI, 2002, section 8.3.2.2.2, 8.4.2.2, 8.5.1.1.1

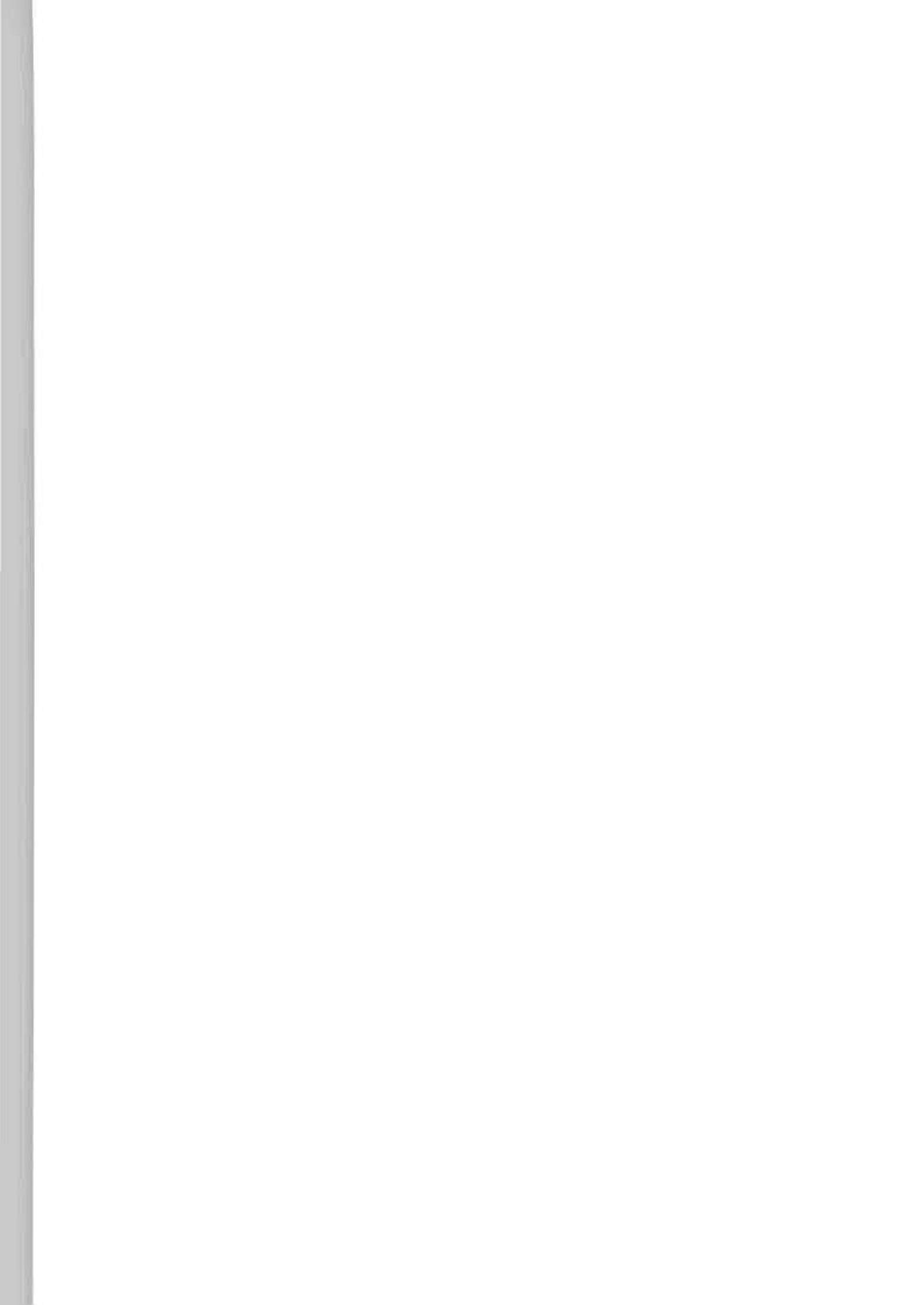



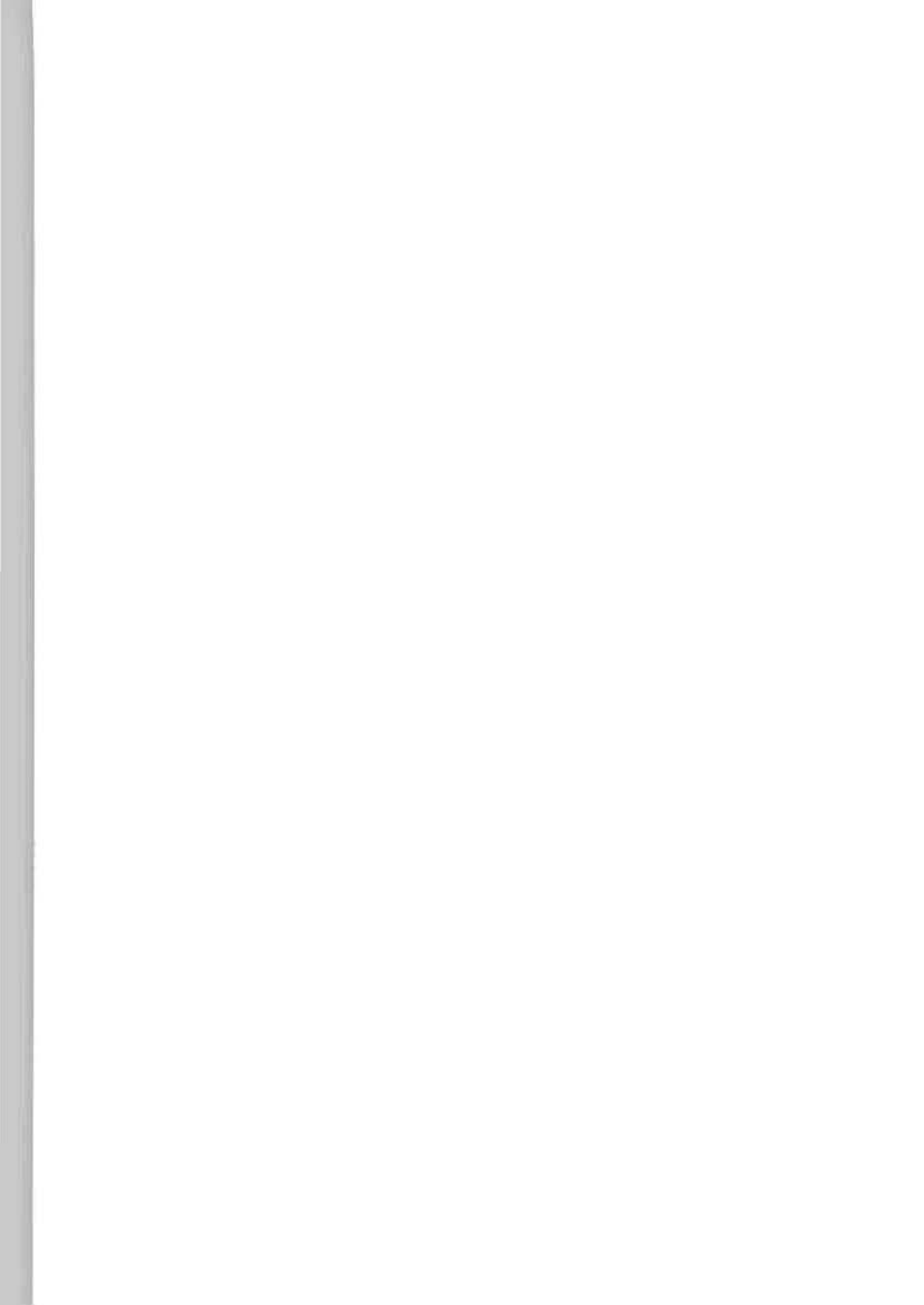



This project was carried out for the Building Disaster Assessment Group within the Office of the Deputy Prime Minister. This group was established to consider the issues, for fire authorities and their fire and rescue services in the UK, that have been highlighted by the World Trade Centre incident of 11 September 2001. This report details work undertaken to identify the current water flows and procedures likely to be found in fire-fighting in high rise buildings, with a number of recommendations to develop and standardise procedure in the UK.

£13.00

ISBN 1 85112 762 3

ISBN 1-851127-62-3

